

ZOLL®

Portable Critical Care Ventilator Operator's Guide

Models: EMV+, AEV, Eagle II



731 Series

906-0731-01 Rev. F

The issue date for the *ZOLL Portable Critical Care Ventilator Operator's Guide* (**REF** 906-0731-01 Rev. F) is **July, 2015**.

Copyright © 2015 ZOLL Medical Corporation. All rights reserved. ZOLL, AEV, EMV+, Eagle II and Smart Help are registered trademarks or trademarks of ZOLL Medical Corporation in the United States and/or other countries. All other trademarks are the property of their respective owners.

Masimo Pulse Oximeter

This device uses Masimo SET® technology to provide continuous pulse oximeter and heart rate monitoring and is covered under one or more of the following U.S.A. patents: 5,758,644, 5,823,950, 6,011,986, 6,157,850, 6,263,222, 6,501,975 and other applicable patents listed at www.masimo.com/patents.htm.



Limited Copyright Release

Permission is hereby granted to any military/governmental agency to reproduce all materials furnished herein for use in a military/governmental service training program and/or other technical training program.

 ZOLL Medical Corporation
269 Mill Road
Chelmsford, MA USA
01824-4105

 QNET, B.V.
Hommerterweg 286
6436 AM Amstenrade
The Netherlands

0459

 **US**
Complies with UL 60601-1
CSA C22.2 No 601.1M90

Table of Contents

List of Figures

Chapter 1 General Information

Product Description	1-1
How to Use this Manual	1-1
Operator's Guide Updates	1-1
Unpacking	1-2
Assembly	1-2
Symbols used on the Equipment	1-2
Conventions	1-5
Abbreviations	1-6
Indications of Use	1-7
Features	1-7
Warnings	1-8
General	1-8
Pulse Oximeter	1-10
Cautions	1-11
FDA Tracking Requirements	1-12
Notification of Adverse Events	1-13
Software License	1-13
Limited Warranty	1-14
Service	1-15

Chapter 2 Product Overview

ZOLL Ventilator Models	2-1
Common Features	2-1
EMV+	2-2
AEV	2-2
Eagle II	2-3
MRI Variants (Eagle II MRI and EMV+ MRI)	2-3
Ventilator Controls and Indicators	2-4
ZOLL Ventilator Features	2-5
Pneumatic Diagram	2-6
Connector Panel	2-7
Controls and Indicators	2-8
Display Screen	2-17
Pop Up messages	2-20

Set-up.....	2-23
External Gas Sources	2-24
Ventilator Circuits: Connections	2-26
Ventilator Circuits: Patient Connections	2-27
Ventilator Circuits: Resistance, Compliance, and Deadspace	2-28
Operating Power Selection and Stopping	2-29
Power Supply Connections	2-30
Self-Check	2-31
Transducer Calibration (AUTO CAL)	2-31
Pulse Oximeter Principles.....	2-32

Chapter 3 Operation

Overview	3-1
Introduction	3-1
Pulse Oximeter	3-2
Operation	3-3
Modes of Operation	3-3
Additional Adjuncts of Operation	3-4
Spontaneous/Assisted Breath Trigger	3-6
To Begin Ventilating	3-7
To Change Settings	3-8
Back Up Ventilator	3-9
Pulse Oximeter	3-9
Humidification	3-9
Hazardous Environment Filters.....	3-11
Bacterial/Viral Filter Use	3-11
Chemical/Biological Filter Use	3-12
Check Valve on Breathing Circuit when in Hazardous Environments	3-12
Harsh Environment Operation.....	3-13
Airborne Particulates	3-13
Extreme Temperature Environments	3-13
Altitude	3-14
Rain and Snow	3-14
Use of Low Flow Oxygen.....	3-15
Use In an MRI Environment.....	3-18

Chapter 4 Alarms

Smart Help Messages.....	4-2
Alarm Priorities	4-3
Ventilator Alarm Categories	4-4
List of Alarms	4-8
Alarm Turn Off and Cancellation.....	4-26
Alarm Turn Off at Extreme Range Limits	4-27
Alarm Cancellation in Alarm Configuration Menu	4-28

Chapter 5 Maintenance

Calibration Checks.....	5-1
General Cleaning.....	5-2
Preventative Maintenance	5-2
Removable Foam Filter Replacement	5-2
Fresh Gas/Emergency Air Intake Disk Filter Replacement.....	5-3
Internal Filter Change/Insertion	5-4
Post-Contaminated Environment Cleaning.....	5-6
Battery Maintenance.....	5-7
Battery Capacity	5-7
Battery Care and Charging	5-7
Internal Battery Change/Insertion	5-9
Recharging Guidelines	5-10
Troubleshooting	5-11
Operator Correctable Problems	5-11
Operating Problems Requiring Service	5-11
Storage	5-11

Appendix A Specifications

General.....	A-1
Pulse Oximeter	A-3
IEC 60601-1.....	A-4

Appendix B Accessories

Index

List of Figures

EMV+ Ventilator	2-2
AEV Ventilator	2-2
Eagle II Ventilator	2-3
Eagle II MRI Ventilator	2-3
ZOLL Ventilator Features	2-4
Pneumatic Diagram	2-6
Connector Panel	2-7
Example: Outlined/Normal Text	2-8
Controls	2-9
Display Screen	2-17
Pop Up Message Example	2-20
External Gas Sources	2-24
Fresh Gas/Emergency Air Intake	2-25
Ventilator Circuit Device Connections	2-26
Ventilator Circuit, Patient Connections	2-27
Connecting and Disconnecting the Power Supply	2-30
Power Supply Latching	2-30
Pulse Oximeter Discrete Saturation Transformation	2-33
Hazardous Environment Filters	3-11
Check Valve Connection To Breathing Circuit	3-12
Oxygen Reservoir Bag Assembly	3-17
ZOLL Ventilator Mounted On MRI Rolling Stand With IV Support Arm	3-19
MR Labels on ZOLL Ventilator	3-20
Smart Help Example	4-1
Smart Help Display	4-2
ZOLL Ventilator Storage Case	5-10

Chapter 1

General Information

Product Description

The ZOLL Portable Critical Care ventilator is a small, extremely durable, full-featured portable mechanical ventilator designed to operate in hospitals or severe and under-resourced environments. It can be used in prehospital, field hospital and hospital settings.

How to Use this Manual

The *ZOLL Portable Critical Care Ventilator Operator's Guide* provides information that operators need for the safe and effective use and care of the ventilator. It is important that all persons using this device read and understand all the information contained within.

Please thoroughly read the warnings section.

Procedures for unit care are located in Chapter 5, "Maintenance".

Operator's Guide Updates

An issue or revision date for this manual is shown on the front cover. If more than 3 years have elapsed since this date, contact ZOLL Medical Corporation to determine if additional product information updates are available.

All users should carefully review each manual update to understand its significance and then file it in its appropriate section within this manual for subsequent reference.

Product documentation is available through the ZOLL website at www.zoll.com. From the **Products** menu, choose **Product Manuals**.

Unpacking

Carefully inspect each container for damage. If the shipping container or cushion material is damaged, keep it until the contents have been checked for completeness and the instrument has been checked for mechanical and electrical integrity. If the contents are incomplete, if there is mechanical damage, or if the ventilator does not pass its electrical self-test, U.S.A. customers should call ZOLL Medical Corporation (1-973-882-1212). Customers outside of the U.S.A. should contact the nearest ZOLL authorized representative. If the shipping container is damaged, also notify the carrier. If there is no apparent sign of mechanical damage, read instructions contained within this manual before attempting operation.







Assembly













The unit only requires that the operator attach the breathing circuit to begin ventilation using either internal or external power. Both the ventilator and breathing circuit are supplied clean and are ready for use on a patient.











The unit's batteries may not be installed within the unit (depending on the contractual requirements or the storage environment as described in the "Battery Care and Recharging" section). Battery installation may be required prior to operation.

Symbols used on the Equipment

Any or all of the following symbols may be used in this manual or on this equipment.

Symbol	Description
	Off
	On
	Direct Current: Identifies the location to connect external DC Power.
	Mute / Cancel: Identifies button which mutes the active alarms or cancels the parameter selection.
	Accept / Confirm: Identifies button which accepts the parameter selection.
	ESD: Warns that connector pins should not be touched.

Symbol	Description
	Defibrillation Proof: Indicates the degree of protection against electrical shock.
	Alarm Bell: Identifies the number of off-screen alarms
	Alarm Bell Outline: Identifies alarm limit settings; Identifies the on-screen alarms.
	Attention: High Priority Alarm Active.
	Caution: Medium Priority Alarm Active.
	Warning: Low Priority Alarm Active.
	Mute: Active Alarm Audible Signal Muted.
	Speaker: Active Alarm Audible Signal
	Oxygen Supply: Oxygen Supply Connected.
	External Power: Indicates the unit is operating using an external power source.
	No External Power: Indicates the unit is operating without an external power source.
	Internal Battery: Provides indication of battery capacity and charging.

Symbol	Description
	No Internal Battery: Indicates when internal battery is not an available power source.
	Heart: Provides indication that the pulse oximeter is in use.
	Rotary Encoder: Identifies the ROTARY ENCODER which allows adjustment of a selected parameter value.
	Do Not Re-Use: This item should not be re-used.
	Do Not Discard: Follow all governing regulations regarding the disposal of any part of this medical device.
SN	Serial Number: Numbers following “SN” indicate the serial number.
	BF Symbol: Protection against electric shock, Type B with floating (F-type) parts.
	Head w/ Mask: The unit is in Non-invasive Positive Pressure Ventilation (NPPV) mode.
	MR Symbol: Identifies the use of the device's ability to perform in a MRI environment.
	Power Input Orientation: Locates the DC input identifying its point of insertion.
	Manufacturer: This symbol shall be adjacent to the name and address of the manufacturer.
	Manufacturer Date: Manufacturer Date Symbol identifies the device's date of manufacture.

Symbol	Description
	Consult Instruction: Consult the instructions for use or operation manual.

Conventions

This guide uses the following conventions:

Within text, the names and labels for physical buttons and softkeys appear in **boldface** type (for example, “Press the **CONFIRM/SELECT** button”).

This guide uses uppercase italics for text messages displayed on the screen (for example, *LEAD FAULT*).

Warning!	Warning statements alert you to conditions or actions that can result in personal injury or death.
-----------------	---

Caution	Caution statements alert you to conditions or actions that can result in damage to the unit.
----------------	--

Abbreviations

A/C - Assist/Control	I:E - Inverse ratio
AEV - Automatic Electrical Ventilator	ID - Internal Diameter
ACLS - Advanced Cardiac Life Support	L - Liters
ALS - Advanced Life Support	LCD - Liquid Crystal Display
ATLS - Advanced Trauma Life Support	LED - Light Emitting Diode
ACV - Assist-Control Ventilation	LPM - Liters Per Minute
AMC - Alarm Message Center	ml - Milliliters
APOD - Advanced Probe Off Detection	mm - Millimeter
ATPD - Atmospheric Temperature and Pressure Dry	MRI - Magnetic Resonance Imaging
b/min - Beats Per Minute	NPPV – Noninvasive Positive Pressure Ventilation
B/V - Bacterial/Viral Filter	O₂ - oxygen
BiPAP - Bilevel positive airway pressure	P_{aw} - Airway Pressure
BPM - Breaths per Minute	PEEP - Positive End Expiratory Pressure
cm H₂O - Centimeters of Water	PIP - Peak Inspiratory Pressure
CPAP - Continuous Positive Airway Pressure	PPV - Positive-Pressure Ventilation
CPR - Cardiopulmonary Resuscitation	PS - Pressure support
CPU - Central Processor Unit	psig - Pounds per Square Inch Gage
dB A- Decibel	RF - Radio Frequency
DISS - Diameter Index Safety System	RGA # - Returned-Goods-Authorization number
EMC - Electromagnetic Compatibility	RTC - Real time clock
EMV - Emergency Medical Ventilator	SIMV - Synchronized Intermittent Mandatory Ventilation
ESD - Electrostatic Discharge	SPM - Smart Pneumatic Module
FIO₂ . Fraction of Inspired Oxygen	USP - United States Pharmacopeia
HME - Heat and Moisture Exchanger	VAC - Volts AC
HMEF - Heat and Moisture Exchanger/Bacterial Viral filter combined	VDC - Volts DC
HP O₂ - High Pressure Oxygen	V_T - Tidal Volume
Hz – Hertz (as in frequency, cycles per second)	WOB – Work Of Breathing

Indications of Use

The devices in the ZOLL ventilator are indicated for use in the management of infant through adult patients weighing ≥ 5 kg with acute or chronic respiratory failure or during resuscitation by providing continuous positive-pressure ventilation. They are appropriate for use in hospitals, outside the hospital, during transport and in severe environments where they may be exposed to rain, dust, rough handling, and extremes in temperature and humidity. With an appropriate third-party filter in place, they may be operated in environments where chemical and/or biological toxins are present. When marked with an “MRI conditional” label, they are suitable for use in an MRI environment with appropriate precautions. The ventilators are intended for use by skilled care providers with knowledge of mechanical ventilation, emergency medical services (EMS) personnel with a basic knowledge of mechanical ventilation, and by first responders under the direction of skilled medical care providers. The EMV+[®] and Eagle II[™] (with and without MRI label) have a full range of ventilation modes (AC, SIMV with or without PS, CPAP with or without PS with PPC or NPPV-PPV). The AEV[®] provides specific modes consistent with pre-hospital care provider’s operating procedures (AC, CPAP with PS and NPPV-PPV).

The ZOLL ventilators are a small, extremely durable, full-featured portable mechanical ventilator designed to operate in hospitals or severe and under-resourced environments. It can be used in prehospital (ALS, ATLS, ACLS), field hospitals, and hospital settings. Easy-to-use, durable, lightweight, and portable, the ZOLL ventilators are built with the same standard of quality, reliability, and performance for which all ZOLL products are known.

Features

- Portable critical care ventilator that can be used in the hospital, aeromedical and ground transport, mass casualty situations, and extreme environments.
- Multiple modes of ventilation for use with acute or chronic respiratory failure in both intubated and non-intubated patients.
- Intuitive operator interface minimizes operator training and protects existing settings from inadvertent contact and manipulation.
- Lightweight (~9.7 lbs, ~4.4 kg) provides for easy transport.
- Rechargeable battery provides over 10 hours of operation (at factory default with pulse oximeter operating).
- Operating temperature range from -25 to 49°C (ZOLL validated testing) and from 10°C to 40°C (SGS listed).
- Altitude compensation from -2,000 to 25,000 ft.
- Self-contained system able to operate with or without external oxygen.
- Gas manifold design allows operation with both high and low-pressure oxygen sources. All oxygen is delivered to the patient breathing circuit.
- Sealed gas path with chemical/biological filter connected to assure safe breathing gas supply.
- Sealed case and control panel protects components from weather and fluids.
- Smart Help messages guide the operator through on-screen commands when responding to alarms.

Warnings

General

- Electric shock hazard: Do not remove equipment covers except to replace the batteries. An operator may only perform maintenance procedures specifically described in this manual. Refer servicing to ZOLL® or an authorized ZOLL® Service Center in the repair of this equipment.
- The device is intended for use by qualified personnel only. The operator should read this manual, all precautionary information, and specifications before using the device.
- Possible explosion hazard if used in the presence of flammable anesthetics or other flammable substances in combination with air, oxygen-enriched environments, or nitrous oxide.
- During operation, the unit should not be stacked on top of or under other medical equipment due to the possibility of electromagnetic interference between the unit and other equipment. Before using on a patient, the operator should observe the device in its normal configuration to assure that EMC interference between equipment is not occurring. (The unit was subjected to EMC testing in accordance with Military Mil-STD-461F, Commercial IEC 60601-1-2, and FDA Reviewers Guidance specification.)
- The equipment set up should not prevent this device from being disconnected from the mains power in an emergency.
- The use of accessories and cables other than those specified, with the exception of accessories and cables sold by ZOLL as replacement parts for internal components, may result in increased emissions or decreased immunity of this device.
Note: The operator should be aware that this device needs special precautions regarding EMC and needs to be installed and put into service according to the EMC information provided in this document.
- The operator should be aware that portable and mobile RF communication equipment may affect the performance of this device. The EMC test specifications for this device are located in the Specifications section of this operator's guide.
- This equipment/system may cause radio interference or may disrupt the operation of nearby equipment. It may be necessary to take mitigation measures, such as re-orienting or relocating of the device or shielding the location.
- The protection against defibrillation depends on the use of accessories (including pulse oximeter) that are specified by ZOLL.
- Grounding:
 - Connect the unit only to a three-wire, grounded, hospital-grade receptacle. The three-conductor plug must be inserted into a properly wired three-wire receptacle; if a three-wire receptacle is not available, a qualified electrician must install one in accordance with the governing electrical code.
 - Do not under any circumstances remove the grounding conductor from the power plug.
 - Do not use extension cords or adapters of any type. The power cord and plug must be intact and undamaged.
 - If there is any doubt about the integrity of the protective earth conductor arrangement, operate the oximeter on internal battery power until the AC power supply protective cover is fully functional.
- To ensure patient electrical isolation, connect only to other equipment with electronically isolated circuits.
- Do not use anti-static or conductive hoses or tubing with this device.
- Do not connect to an electrical outlet controlled by a wall switch or dimmer.
- As with all medical equipment, carefully route the ventilator circuit hose and tubing, patient cabling, and external power cables to reduce the possibility of patient entanglement or strangulation.

-
- Do not place the unit or external power supply in any position that might cause it to fall on the patient. Do not lift the unit by the power supply cord, ventilator circuit, or pulse oximeter patient cable.
 - Do not use the unit during magnetic resonance imaging (MRI) scanning unless it has the appropriate “MRI conditional” label. See “Use in an MRI Environment” for instructions on the use of MRI conditional units, which details additional Warnings and Cautions.
 - The unit must be connected to a grounded AC power supply when connected to AC power. The unit and its ZOLL-supplied integrated pulse oximeter are referred to as an IEC 601/F device in the summary situation table contained in IEC-601-1-1.
 - USB Interconnection: Do not operate the device on a patient when the USB is connected to any other device.

Note: The USB interconnection does not support automatic record keeping.

- The ZOLL-supplied ventilator circuit’s labeling provides the resistance and compliance values for the circuits under normal operating conditions. If added accessories are used (e.g. humidification, filters etc.), the operator should assure they do not degrade the performance of the device. If non-ZOLL circuits are used, the operator should assure these circuits do not affect the performance of the device.
- This device has altitude compensation between -2000 to 25,000 ft (-610 to 7620 m). If operating outside this range, an *Excessive Altitude* (3131) alarm will sound. Compensation for altitude and the performance of the device outside of this range must be managed by the operator under the direction of a physician.
- This device has been tested to perform in humidity levels as specified in MIL-STD-810F. Use outside the specified range is not recommended for extended periods.
- Do not modify this equipment without authorization of the manufacturer.
- Disconnect electrical power supply before servicing.
- *Never* service the ventilator while in use with a patient.
- Pins of connectors identified with the ESD warning symbol should not be touched and connections should be made to these connectors unless ESD precautionary procedures are used.

Note: Staff must be made aware that accessible pins of connectors identified with the ESD warning symbol should not be touched with the fingers or with a hand-held tool unless proper precautionary procedures have been followed.

Precautionary procedures include:

- Methods to prevent build-up of electrostatic charge (e.g. air conditioning, humidification, conductive floor coverings, non-synthetic clothing).
- Discharging one’s body to the frame of the device or to earth or a large metal object.
- Bonding oneself by means of a wrist strap to the device or to earth.

Note: Staff that could touch connectors identified with the ESD warning symbol should receive this explanation and training. This includes clinical/biomedical engineering and health-care staff.

Note: ESD training should include an introduction to the physics of electrostatic discharge, the voltage levels that can occur in normal practice, and the damage that can be done to electronic components if equipment are touched by an operator who is electrostatically charged. Further, an explanation should be given of methods to prevent build-up of electrostatic charge, and how and why to discharge one’s body to earth or to the frame of the device, or bond oneself by means of a wrist strap to the device or to earth prior to making a connection.

- This operator’s guide is not meant to supersede any controlling operating procedure regarding the safe use of assisted ventilation. Follow all governing regulations regarding the disposal of any part of this medical device, the handling of materials contaminated by body fluids, and shipment of the Li batteries.
- This device is not intended for use in explosive atmospheres.

Pulse Oximeter

- A pulse oximeter should not be used as an apnea monitor.
- A pulse oximeter should be considered an early warning device. As a trend towards patient deoxygenation is indicated, blood samples should be analyzed by a laboratory co-oximeter to completely understand the patient's condition.
- Measurements: if the accuracy of any measurement does not seem reasonable, first check the patient's vital signs by alternate means and then check the pulse oximeter for proper functioning.
Inaccurate measurements may be caused by:
 - Incorrect sensor application or use.
 - Significant levels of dysfunctional hemoglobin (e.g. carboxyhemoglobin or methemoglobin).
 - Intravascular dyes such as indocyanine green or methylene blue.
 - Exposure to excessive illumination, such as surgical lamps (especially ones with a xenon light source), bilirubin lamps, fluorescent lights, infrared heating lamps, or direct sunlight (exposure to excessive illumination can be corrected by covering the sensor with a dark or opaque material).
 - Excessive patient movement.
 - Venous pulsations.
 - Placement of a sensor on an extremity with a blood pressure cuff, arterial catheter, or intravascular line.
 - The pulse oximeter can be used during defibrillation, but the readings may be inaccurate for a short time.
- Interfering Substances: carboxyhemoglobin may erroneously increase readings. The level of increase is approximately equal to the amount of carboxyhemoglobin present. Dyes, or any substance containing dyes, that change usual arterial pigmentation may cause erroneous readings.
- Alarms: Check alarm limits each time the pulse oximeter is used to ensure that they are appropriate for the patient being monitored.
- Loss of pulse signal can occur in any of the following situations:
 - The sensor is too tight.
 - There is excessive illumination from light sources such as a surgical lamp, a bilirubin lamp, or sunlight.
 - A blood pressure cuff is inflated on the same extremity as the one with an SpO₂ sensor attached.
 - The patient has hypotension, severe vasoconstriction, severe anemia, or hypothermia.
 - There is arterial occlusion proximal to the sensor.
 - The patient is in cardiac arrest or is in shock.
- Sensors:
 - Before use, carefully read the LNCS[®] sensor directions for use.
 - Use only Masimo oximetry sensors for SpO₂ measurements. Other oxygen transducers (sensors) may cause improper performance.
 - Tissue damage can be caused by incorrect application or use of an LNCS[®] sensor for example, by wrapping the sensor too tightly. Inspect the sensor site as directed in the sensor **Directions for Use** to ensure skin integrity and correct positioning and adhesion of the sensor.
 - Do not damage LNCS[®] sensors. Do not use an LNCS[®] sensor with exposed optical components. Do not immerse the sensor in water, solvents, or cleaning solutions (The sensors and connectors are not waterproof). Do not sterilize by irradiation, steam, or ethylene oxide. See the cleaning instructions in the directions for reusable Masimo LNCS[®] sensors.

-
- Do not use damaged patient cables. Do not immerse the patient cables in water, solvents, or cleaning solutions (the patient cables are not waterproof). Do not sterilize by irradiation, steam, or ethylene oxide. See the cleaning instructions in the directions for reusable Masimo patient cables.
 - Do not use the pulse oximeter or pulse oximetry sensors during magnetic resonance imaging (MRI) scanning. Inducing current could potentially cause burns. The pulse oximeter may affect the MRI image and the MRI unit may affect the accuracy of the oximetry measurements.

Cautions

- The circuit should be inspected every day to ensure that there is no damage or wear that could affect its performance. Fluid or other biological material should be removed from the circuit or the circuit should be replaced following the local standard of care.
- Federal law restricts this device to sale by or on the order of a physician.
- Service is to be performed by qualified biomedical equipment technicians only.
- Internal components are susceptible to damage from static discharge. Do not remove device covers.



- Possession or purchase of this device does not convey any expressed or implied license to use the device with unauthorized sensors or cables which would, alone, or in combination with this device fall within the scope of one or more of the patents related to this device. ZOLL cannot ensure the proper functioning of this device if it is used with unauthorized sensors or cables.

FDA Tracking Requirements

U.S. Federal Law (21 CFR 821) requires the tracking of ventilators. Under this law, owners of this ventilator must notify ZOLL Medical Corporation if this product is

- received
- lost, stolen, or destroyed
- donated, resold, or otherwise distributed to a different organization

If any such event occurs, contact ZOLL Medical Corporation in writing with the following information:

1. Originator's organization – Company name, address, contact name, and contact phone number
2. Model number, and serial number of the ventilator
3. Disposition of the ventilator (for example, received, lost, stolen, destroyed, distributed to another organization), new location and/or organization (if known and different from originator's organization) – company name, address, contact name, and contact phone number
4. Date when the change took effect

Please address the information to:

ZOLL Medical Corporation
Attn: Tracking Coordinator
269 Mill Road
Chelmsford, MA 01824-04105
Fax: (978) 421-0022
Telephone: (973) 882-1212

Notification of Adverse Events

As a health care provider, you may have responsibilities under the Safe Medical Devices Act (SMDA), for reporting to ZOLL Medical Corporation, and possibly to the FDA, the occurrence of certain events.

These events, described in 21 CFR Part 803, include device-related death and serious injury or illness. In addition, as part of our Quality Assurance Program, ZOLL Medical Corporation requests to be notified of device failures or malfunctions. This information is required to ensure that ZOLL Medical Corporation provides only the highest quality products.

Software License

Note: Read this Operator's Guide and License agreement carefully before operating any of the ZOLL ventilator products.

Software incorporated into the system is protected by copyright laws and international copyright treaties as well as other intellectual property laws and treaties. This software is licensed, not sold. By taking delivery of and using this system, the Purchaser signifies agreement to and acceptance of the following terms and conditions:

1. **Grant of License:** In consideration of payment of the software license fee which is part of the price paid for this product, ZOLL Medical Corporation grants the Purchaser a nonexclusive license, without right to sublicense, to use the system software in object-code form only.
2. **Ownership of Software/Firmware:** Title to, ownership of, and all rights and interests in the system software and all copies thereof remain at all times vested in the manufacturer, and Licensors to ZOLL Medical Corporation and they do not pass to purchaser.
3. **Assignment:** Purchaser agrees not to assign, sublicense, or otherwise transfer or share its rights under the license without the express written permission of ZOLL Medical Corporation.
4. **Use Restrictions:** As the Purchaser, you may physically transfer the products from one location to another provided that the software/firmware is not copied. You may not disclose, publish, translate, release, or distribute copies of the software/firmware to others. You may not modify, adapt, translate, reverse engineer, decompile, crosscompile, disassemble, or create derivative works based on the software/firmware.

NO IMPLIED LICENSE

Possession or purchase of this device does not convey any express or implied license to use the device with replacement parts which would, alone, or in combination with this device, fall within the scope of one or more of the patents relating to this device.

Limited Warranty

ZOLL warrants the device to be free from all defects in material and workmanship for a period of one (1) year from the date of delivery to the original purchaser.

During the warranty period, ZOLL will repair or replace the device or any part which upon examination is shown to be defective. At its sole discretion, ZOLL may choose to supply a new or equivalent replacement product or refund the amount of the purchase price (on the date sold by ZOLL). To qualify for such repair, replacement, or refund, the defective device must be returned to the ZOLL Service Center within thirty (30) days from the date that the defect is discovered. This warranty does not apply if the device has been repaired or modified without the authorization of ZOLL or if the damage was caused by incorrect (off-label) use, negligence, or an accident.

Batteries, which by their nature are consumable and subjected to environmental extremes, will be warranted only for a period of ninety (90) days. Accessories, also consumable in usage, such as connecting hose and breathing circuits, are not warranted.

DISCLAIMER OF IMPLIED & OTHER WARRANTIES:
THE PRECEDING WARRANTY IS THE EXCLUSIVE WARRANTY AND ZOLL MAKES NO OTHER WARRANTY OR REPRESENTATION OF ANY KIND WHATSOEVER, EXPRESS OR IMPLIED, WITH RESPECT TO MERCHANTABILITY, FITNESS FOR A PARTICULAR PURPOSE, OR ANY OTHER MATTER. THE REMEDIES STATED IN THIS DOCUMENT WILL BE THE EXCLUSIVE REMEDIES AVAILABLE TO THE CUSTOMER FOR ANY DEFECTS OR FOR DAMAGES RESULTING FROM ANY CAUSE WHATSOEVER AND WITHOUT LIMITATION.

ZOLL WILL NOT IN ANY EVENT BE LIABLE TO THE CUSTOMER FOR CONSEQUENTIAL OR INCIDENTAL DAMAGES OF ANY KIND, WHETHER FOR DEFECTIVE OR NONCONFORMING PRODUCTS, BREACH OR REPUDIATION OF ANY TERM OR CONDITION OF THIS DOCUMENT, NEGLIGENCE, OR ANY OTHER REASON.

Service

If a unit requires service, contact the ZOLL Technical Service Department.

For customers In the U.S.A.		For customers outside the U.S.A.
Telephone:	1-978-421-9655	Call the nearest authorized ZOLL Medical Corporation representative.
Fax:	1-978-421-0010	To locate an authorized service center, contact the International Sales Department at
Email:	techsupport@zoll.com	ZOLL Medical Corporation 27 Fairfield Place, P.O. Box 508 West Caldwell, NJ 07007-0505 Telephone: 1-973-882-1212

When requesting service, please provide the following information to the service representative:

- Unit serial number
- Description of the problem
- Department using the equipment and name of the person to contact
- Purchase order to allow tracking of loan equipment
- Purchase order for a unit with an expired warranty

Returning a unit for service

Before sending a unit to the ZOLL Technical Service Department for repair, obtain a service request (SR) number from the service representative.

The Lithium ion battery should remain inside the unit. Follow directions provided on the RGA. Pack the unit with its cables in the original containers (if available) or equivalent packaging. Be sure the assigned service request number appears on each package.

For customers	Return the unit to
In the U.S.A.	ZOLL Medical Corporation 27 Fairfield Place, P.O. Box 508 West Caldwell, NJ 07007-0508 Attention: Technical Service Department (<i>SR number</i>) Telephone: 1-973-882-1212
In Canada	ZOLL Medical Canada Inc. 1750 Sismet Road, Unit #1 Mississauga, ON L4W 1R6 Attention: Technical Service Department (<i>SR number</i>) Telephone: 1-866-442-1011

GENERAL INFORMATION

For customers	Return the unit to
In other locations	The nearest authorized ZOLL Medical Corporation representative. To locate an authorized service center, contact the International Sales Department at ZOLL Medical Corporation 269 Mill Road Chelmsford, MA 01824-4105 Telephone: 1-978-421-9655

Chapter 2

Product Overview

ZOLL Ventilator Models

The ZOLL Critical Care ventilator is designed to manage infant through adult patients with acute or chronic respiratory failure or during resuscitation by providing continuous positive-pressure ventilation. (See “Indications of Use”)

The ventilator comes in five models:

- EMV+
- EMV+ MRI
- Eagle II
- Eagle II MRI
- AEV

Common Features

- Rugged design
- Weight: ~10 lbs
- 10 hour battery life
- Rapid charger to achieve 90% battery capacity in 2 hours
- Pressure and volume ventilation modes: AC, SIMV with or without PS, CPAP with or without PS, with and without NPPV/PPV
- Pressure support
- Leak compensation
- High performance internal compressor
- PEEP control
- Smart Help messages
- Masimo SET Measure through Motion
- Low-Perfusion Pulse Oximetry
- Integral SpO₂
- Airworthiness Release
- Daylight visible display

- Oxygen efficient
- Supports infant, pediatric, and adult patients
- Limited 1 year warranty

EMV+

The EMV+ ventilator's rugged design makes it ideal for use in emergency vehicle and air transport of patients. It has a wide range of ventilation modes, such as AC, SIMV with or without PS, and CPAP with or without PS with NPPV-PPV.



EMV+ Ventilator

AEV

The AEV ventilator is built for managing ventilator support patients during ambulance transport. It's ventilation modes (AC, CPAP with PS and NPPV) are specifically chosen to be consistent with pre-hospital care provider's operating procedures.



AEV Ventilator

Eagle II

The Eagle II ventilator adapts the ventilation modes for the EMV+ (AC, SIMV with or without PS, CPAP with or without PS with NPPV-PPV) for use by intensive care units, emergency departments, and intra-hospital transport. It's design also allows it to be mounted onto walls or onto specified boom arms and roll stands as well as gurneys.

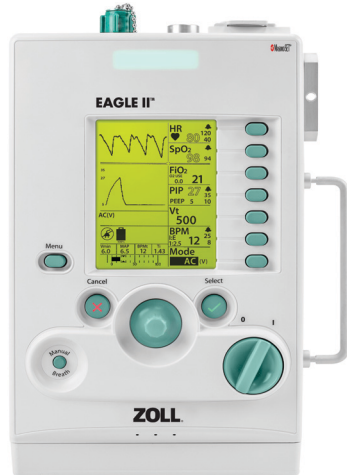

Eagle II Ventilator

MRI Variants (Eagle II MRI and EMV+ MRI)

The Eagle II MRI and EMV+ MRI ventilators have been approved for use in MRI suites. These devices have been successfully tested to operate in 3.0 Tesla environments and can be placed approximately 6 1/2 ft. from the bore opening for easy and safe access to the patient. The devices come with two 12 ft. MRI patient circuits and can be mounted on an available MRI conditional roll stand.

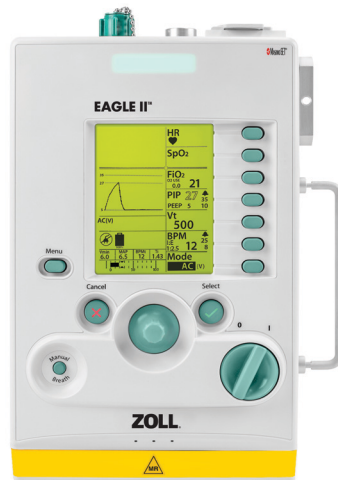

Eagle II MRI Ventilator

Note: The Pulse Oximeter cannot be used in an MRI environment.

Ventilator Controls and Indicators

The following illustration shows the ZOLL ventilator's main features:

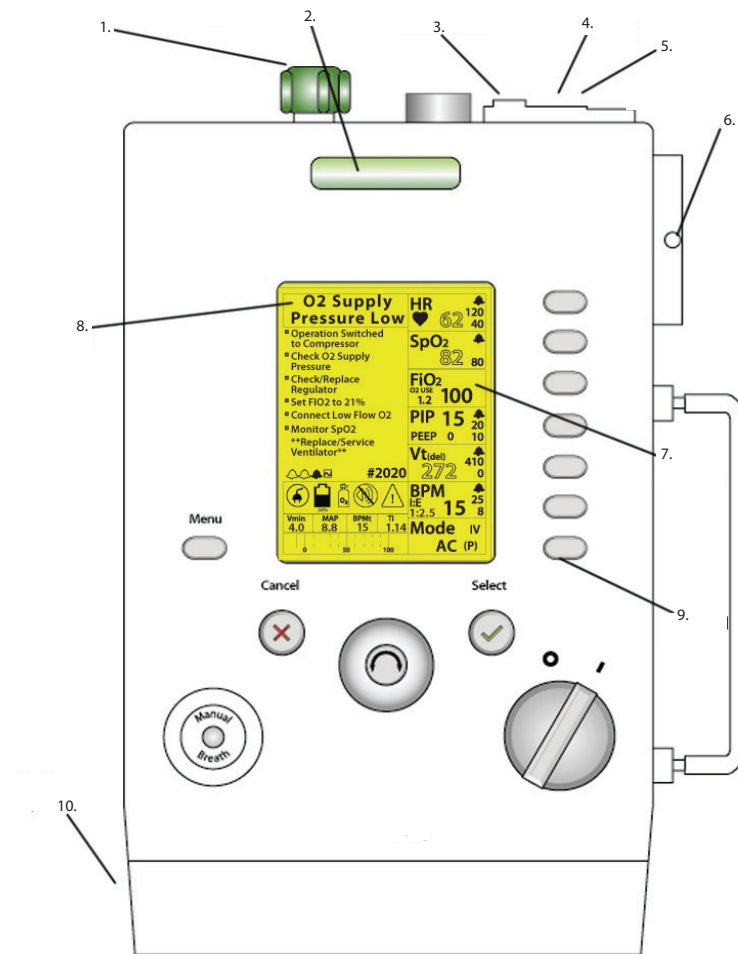

ZOLL Ventilator Features

ZOLL Ventilator Features

	Item	Description
1.	Oxygen Inlet	Connects the unit to an external oxygen source
2.	Status Indicator LED Array	Lights up to indicate status of the unit, connected to alarms
3.	External Power Input Connector	Connects the unit to an external power source
4.	USB Connector	Connects the unit to a USB drive or USB compatible device
5.	Pulse Oximeter Connector	Connects the unit to a Pulse Oximeter sensor
6.	Fresh Gas/Emergency Air Intake	Allows the unit's internal compressor to take ambient air and acts as an anti-asphyxia valve
7.	LCD Display	Displays the unit's settings, patient data, and alarm information
8.	Alarm Message Center	Displays active alarms and mitigation information
9.	Control Panel	Access to the unit settings
10.	Battery Compartment	Contains the unit's rechargeable lithium ion battery

Pneumatic Diagram

The following image is a diagram of the ZOLL ventilator's pneumatic design.

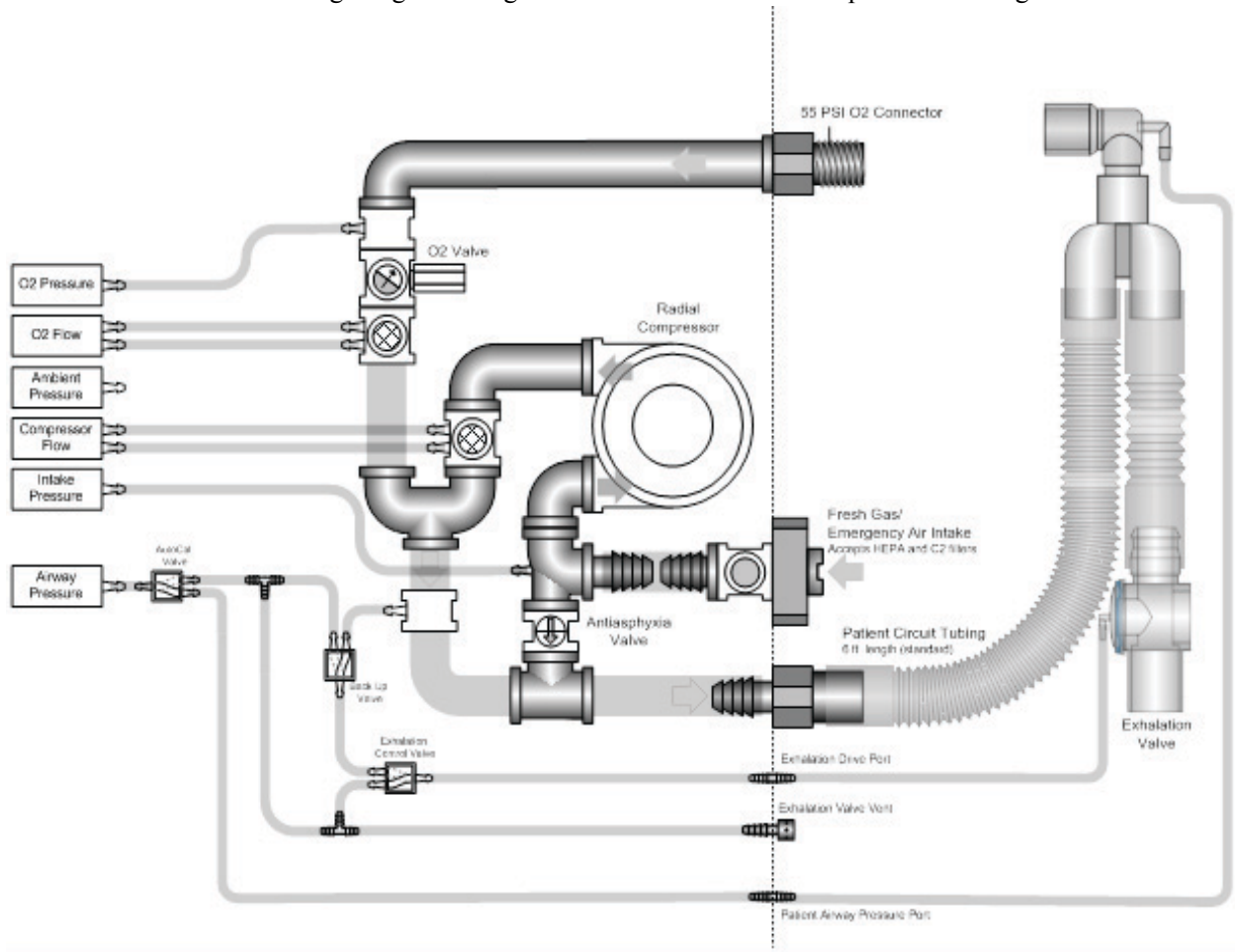

Pneumatic Diagram

Connector Panel

The ZOLL ventilator Connector Panel appears as follows:

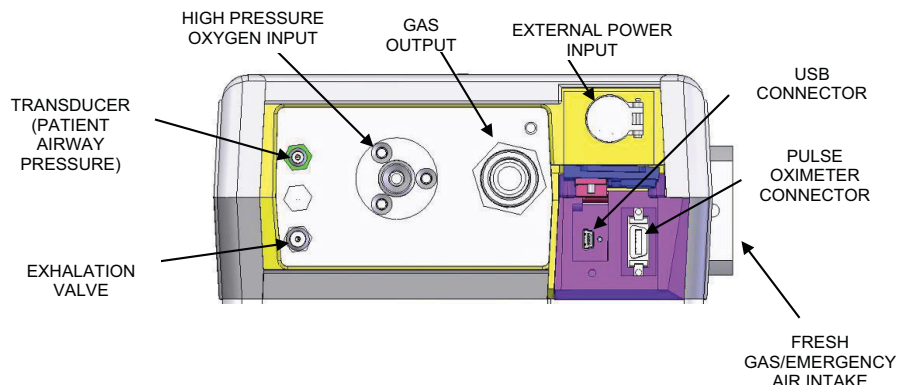

Connector Panel

The connector panel for the ZOLL ventilator unit has the following components:

Oxygen Input -- connects the unit to the output of an appropriate oxygen regulator attached to a medical-grade (USP) oxygen cylinder. The OXYGEN IN fitting has a male oxygen Diameter Index Safety System (D.I.S.S.) thread. A green (white in some installations), 6 foot long high-pressure oxygen hose with compatible fittings that provides for connection between the unit and the oxygen source is required. (Also see “Harsh Environment Operation” section).

Note: If external oxygen is connected, the gas pressure must be at least 41-psig (± 2 psig) when SELF-CHECK is performed.

Gas Output -- connects to the ventilator circuit 22 mm ID corrugated hose. The connector is a 22 mm male conical connection.

Fresh Gas/Emergency Air Intake -- allows ambient air into the unit’s internal compressor. The port also functions as the internal anti-asphyxia valve, which allows the patient to breathe ambient air in the event of a ventilator failure. The intake contains a particulate filter and permits the operator to connect either a bacterial/viral or a chemical/biological filter depending on ambient conditions.

Transducer (Patient Airway Pressure) -- connects to the ventilator circuit 3/16” ID transducer tubing. The barb-type connector is colored a green/blue to distinguish it from the other connectors.

Note: The 3/16” ID ventilator circuit transducer tubing is a green/blue (darker) color.

Exhalation Valve -- connects to the ventilator circuit 1/4” ID exhalation valve tubing. The barb-type connector is clear anodized aluminum to distinguish it from the other connectors.

Note: The 1/4” ID ventilator circuit exhalation valve tubing is clear.

External Power Input -- accepts DC voltage between 12.5 and 28 volts (negative ground). The input mates with the output connector plug of the AC/DC Power Supply, 12 and 28 VDC Power Cables (both are available as accessories) or the external battery.

USB Connector -- connects the unit to a USB drive or any USB compatible device.

Pulse Oximeter Connector -- connects the unit to a pulse oximeter sensor probe.

Controls and Indicators

The unit contains various controls and indicators that are placed to facilitate ease of use and visibility in all operating environments. A liquid crystal display (LCD) provides continuous display of control settings, operating conditions, power, and alarm status information. The location of each control and indicator is shown in the figure below (their respective location callouts are listed below). Most unit functions are controlled by pressing the Parameter button associated with the parameter you wish to change. Pressing the Parameter button highlights the primary parameter; additional presses highlight secondary parameters moving in a clockwise direction. When the parameter you wish to change is highlighted, turn the **ROTARY ENCODER** clockwise or counter clockwise to adjust the parameter to the desired value and confirm the new value by pressing the **CONFIRM/SELECT** button. Once this is done, the highlight goes away and the unit begins operation using the new parameter. The operator may cancel any operation and return to the primary operating screen by pressing the **MUTE/CANCEL** button. A parameter stays highlighted for 5 seconds; after this time, the unit automatically cancels the operation and returns to the default screen. Additional functionality associated with a parameter is viewed in Context Menus which are accessed by pressing and holding the parameter button for ~1 second. Parameter and their associated Context Menus are described below.

To assist the operator in recognizing parameters that can be changed and those that are dependent on the patient, the unit uses “Outlined” text to demonstrate patient dependent values. Parameters in Outlined text cannot be adjusted. For example, during volume targeted ventilation the PIP value is displayed as outlined text because it is dependent on the patient’s resistance and compliance. In pressure targeted ventilation the tidal volume is outlined text.

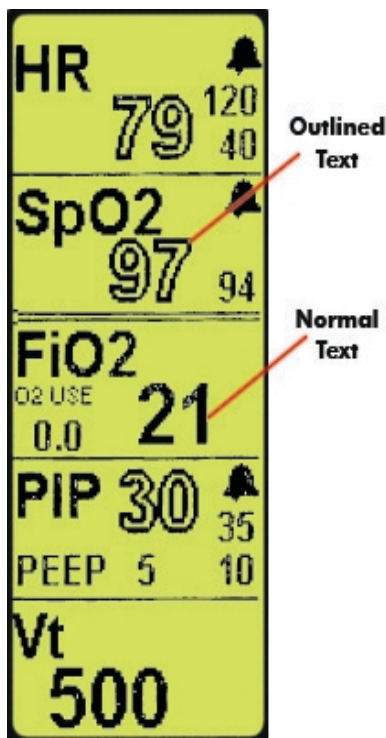

Example: Outlined/Normal Text

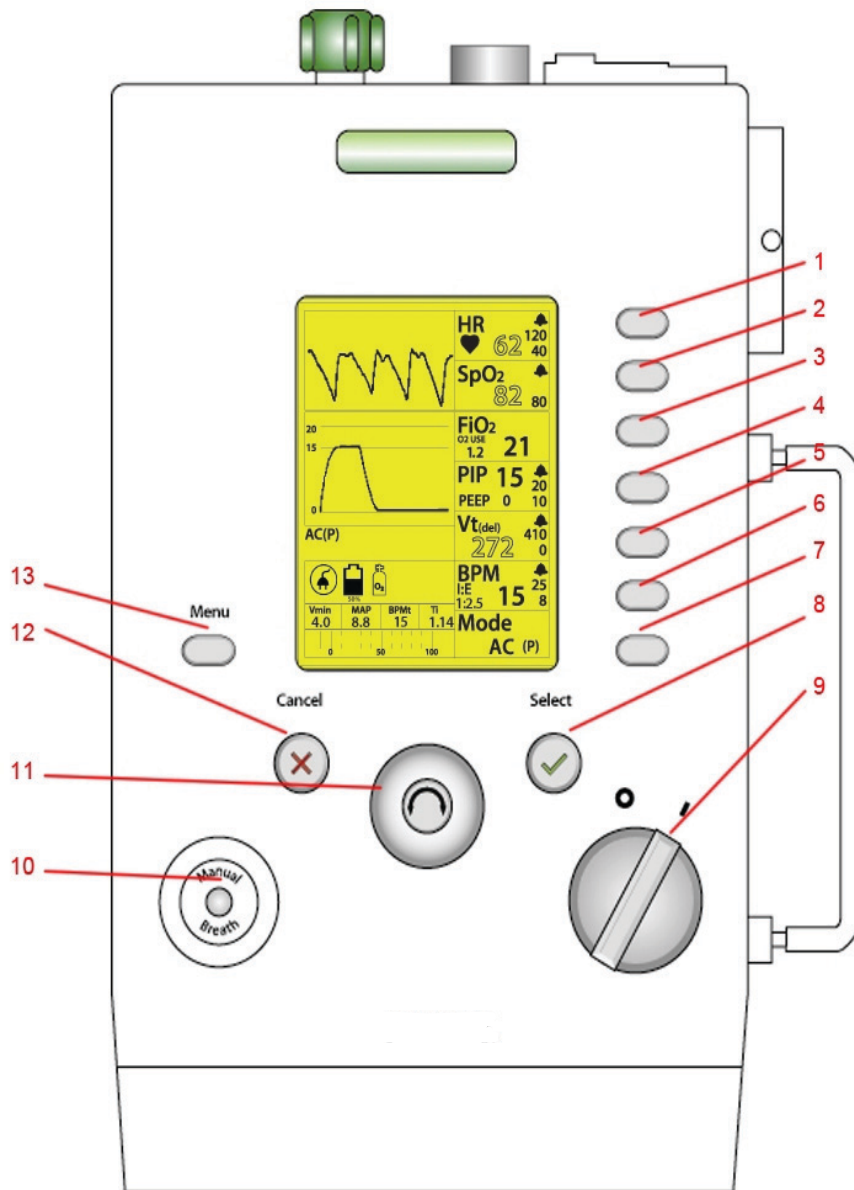

Controls

The Control Panel incorporates all controls and the LCD display. The controls consist of buttons, a **Power Off/On** switch, and a **Rotary Encoder** that we describe in the following section. Context Menu controls are shown in tables associated with their parameter button.

1. **HR** -- Pressing the **HR** button highlights the High Heart Rate alarm limit and enables its value to be changed. Pressing the **HR** button a second time will highlight the current value of the Low Heart Rate Alarm limit and enable its value to be changed. The HR parameters are functional only when the pulse oximeter is connected. Both limits are adjustable by 1 b/min. The default value at start up for the high alarm limit is 120 b/min; the low alarm

limit is 40 b/min. To access the HR context menu, press and hold the **HR** parameter button. The HR context menu provides control of the pulse oximeter settings.

Masimo Context Menu		
Menu Item	Range	Description
Averaging	2-4, 4-6, 8, 10, 12, 14, 16 (t=sec)	Adjusts the SpO ₂ and HR averaging durations
Sensitivity	Norm, Max	Default: Norm, adjusts the pleth signal sensitivity. Max is designed to interpret and display data for even the weakest of signals. This choice is recommended during procedures and when clinician and patient contact is continuous.
Fast SAT	Off, On	Default: Off, Fast SAT enables rapid tracking of arterial oxygen saturation changes by minimizing the averaging. This mode is clinically applicable during procedures when detecting rapid changes in SpO ₂ is paramount such as induction, intubation, and sleep studies.
APOD	Off, On	Default: Off, When on, this mode improves detection of the “probe off patient” condition, but reduces the ability to acquire a reading on patients of low perfusion.
Signal Strength	0 to 20	Current signal strength value, not adjustable. A value of zero indicates that no measurement is available. This value helps clinicians place sensors on optimal sites.
Signal IQ	Bar graph	Bar graph displays the relative reliability of the pulse oximeter signal.

2. **SpO₂** -- Pressing the **SpO₂** button highlights the Low SpO₂ Alarm Limit and enables its value to be changed. The SpO₂ display is active only when the pulse oximeter is connected. When no SpO₂ sensor is connected or if the probe is off the patient during start up or the operator places the pulse oximeter in standby (*stby*) is displayed in the parameter window. The default low SpO₂ value at start up is 94%. SpO₂ uses the same Context Menu as HR.
3. **FIO₂** -- Pressing the **FIO₂** button highlights the current value and enables it to be changed. There are no adjustable secondary parameters. The default values at start up is 21% whether oxygen is present or not. If an FIO₂ value greater than 21% is saved and used for Power Up settings, the unit will start up with that saved FIO₂ value if high-pressure oxygen is present. If high-pressure oxygen is *not* present, the unit will start up with FIO₂ = 21% and *O₂ SUPPLY PRESSURE LOW* alarm will *not* be activated. The secondary display in the parameter window is O₂ Use¹. This is the flow (liters/min) of high pressure oxygen used by the unit to support the patient at the current settings. O₂ Reservoir mode is indicated on the display with a plus “+” sign next to the FIO₂ value when this mode is active. (The “O₂ Use” value does not include oxygen use in the O₂ Reservoir.)

1. $O_2 \text{ Use} = ((FIO_2 - 0.21) / 0.79) * \text{Minute Volume}$ where FIO₂ is represented as a fraction and minute volume is the actual minute volume (controlled and spontaneous breaths * tidal volume).

4. **PIP (Peak Inspiratory Pressure)** -- In volume targeted modes, the primary field shows the delivered PIP as outline text. In pressure targeted modes, the PIP target is displayed and is adjustable. The PIP High Limit, PIP Low Limit, and PEEP are also available as secondary parameters.

PIP Context Menu		
Menu Item	Range	Description
Pressure Support*	0 to 60	PS value is the pressure over the PEEP setting

*See “Additional Modes of Operation” for additional information on Pressure Support

Note: PIP values greater than 60 cm H₂O require the operator to perform a separate confirmation.

5. **V_T (Tidal Volume)** -- In volume targeted modes, pressing the V_T button highlights the current set tidal volume and enables it to be changed. In pressure targeted breaths, the delivered tidal volume is shown as outlined text and is based on the patient pulmonary mechanics. The V_T High and Low Limits are also available as secondary parameters.

Note: In the CPAP-NPPV, the V_T delivered and V_{min} may be overestimates of the true volume going to the patient when leaks are present. The O₂ Use values will accurately display the O₂ use though the amount used will be more than if no leak was present.

Warning! If significant leaks are present during CPAP-NPPV, the V_T delivered and V_{min} shown may be overestimates of what is actually being delivered to the patient. The adequacy of ventilation should be assessed using an alternate method.

6. **BPM (Breaths Per Minute)** -- Pressing the BPM button highlights the current breathing rate and enables it to be changed. Secondary parameters include high breath rate, low breath rate, and I:E ratio, which can be adjusted by pressing the Parameter button the appropriate number of times. During CPAP operation, the patient’s actual breathing rate is displayed as the BPM primary parameter in outlined text.

BPM Context Menu		
Menu Item	Range	Description
Control Parameter	I:E, TI	Allows operator to select independent variable
Rise Time	1 to 10	Determines the speed of the rise flow: low values fast rise, high values low rise
Cycle Off%	10 to 70% (default 25%)	Allows operator to adjust Cycle Off%

Control Parameter -- the operator can select which parameter is dependent or independent. Selecting I:E results in the ventilator maintaining the I:E Ratio while the Inspiratory time (T_I) varies when the breathing rate is changing. Selecting T_I maintains a constant Inspiratory time while the I:E ratio varies when the rate is changed.

Rise Time -- the unit allows the operator to adjust the time it takes to reach the full respiratory flow and peak Inspiratory pressure during pressure targeted breathing and when pressure support is being used. The range is 1 to 10 where 1 is the shortest rise time and 10 is the longest rise time. When the unit is turned on, either the default Rise Time or a User Rise Time will be used. Using the Pressure-Time waveform as reference will assist the operator in setting the Rise Time.

The Rise Time settings should be reassessed and adjusted after the patient is placed on the ventilator and initially stabilized. To minimize patient’s work of breathing and potential for pressure overshoots, operators must take the following into consideration when setting the Rise Time:

- Patient’s respiratory pattern
- Patient’s comfort
- Patient’s flow demand
- Resistance (Mechanical/Physiological)
- Compliance characteristics

The Rise Time for a passive lung is driven primarily by airway resistance, and is fairly independent of compliance.

Resistance	Rise Time
5	1
20	3
50	5
200	10

An adult patient with high Resistance may benefit from a Rise Time setting of 3 to 4 for optimal breath delivery. Rise Times of 8-10 are optimized for infants and are flow limited. (The infant circuit is not intended for flows > 60 LPM.)

Cycle Off% -- the unit allows the operator to adjust the Cycle Off%. The primary purpose of this parameter is to set a fraction of peak flow at which inspiration ends and exhalation begins. A key application for Cycle Off% is to adjust for leaks present in and around the patient circuit or the patient themselves.

Note: The longest duration of a spontaneous pressure supported breath is limited to 5 seconds. At the end of this time, the ventilator ends flow and opens the exhalation valve. (All other breaths are time cycled.)

- Cycle Off% is principally made available as a parameter for NPPV mode, where a much higher setting is required to cycle the breath properly in the presence of a leak. If a higher value is not used and there is a leak, the tendency will be for the system to time cycle at 5 seconds instead of flow cycle. This is due to the fact that the leak flow might be higher than 25% of the peak flow, so the cycle threshold is never crossed.
- If there is no leak, increasing the Cycle Off% will cause breaths to cycle sooner, thus delivering less volume. If it is set too high, the breath will end early relative to patient effort and may lead to the triggering of a second breath.

Note: Clinicians must carefully assess the patient’s response to the Cycle Off% application and must carefully adjust the flow cycle setting to optimize patient ventilatory support and comfort.

7. **Mode** -- Pressing the **MODE** button will highlight the current ventilation mode. Pressing the Parameter button again will allow for the selection of volume or pressure targeting which is shown as either “(V)” for volume or “(P)” for pressure. Selecting volume assures a constant volume is delivered to the patient in the inspiratory time using a constant flow. Pressure targeting ventilation provides a constant airway pressure for the duration of the inspiratory time using a decelerating flow pattern. See “Additional Modes of Operation” for a

description of how to enter the NPPV (Noninvasive Positive Pressure) adjunct in the Mode parameter window. To access the Mode Context menu, press and hold the **MODE** parameter button. This will permit the Apnea Back Up settings to be set.

Mode Context Menu		
Menu Item	Range	Description
BPM	1 to 60	Allows operator to select BPM for Apnea Back Up
PIP Target	10 to 80	Allows operator to select the PIP Target for Apnea Back Up
I:E, TI	1:1 to 1:99, 0.3 to 3	Allows operator to select either I:E or TI for Apnea Back Up

When going into Apnea Back Up from CPAP in the EMV+[®] and Eagle II[™] (NPPV and PPV), and in the AEV[®] (NPPV only), the unit will automatically return to Pressure with the following back up settings:

PIP Target	BPM	I:E OR T _I
20	12	1:2.5 OR 1.42

All other parameters will remain as they were previously set. When leaving CPAP, the new operating mode will be Pressure Targeted and will use Apnea Back Up settings as the new settings.

Caution These Apnea Back Up settings are appropriate for an adult. For pediatric and infant patients, the operator should adjust the Apnea Back Up settings so they are appropriate for the patient.

8. **Confirm/Select** -- Press the **CONFIRM/SELECT** button to confirm a new control setting or to select from a menu or setting option. The **CONFIRM/SELECT** button switch is labeled with a green check mark "✓".
9. **Power Off/On** -- Turn the **POWER OFF/ON** switch to apply or remove operating power to the unit.
10. **Manual Breath** -- Pressing the **MANUAL BREATH** button delivers one control breath based on the V_T or PIP settings. If the **MANUAL BREATH** button is pressed during inspiration or before baseline is reached in the expiratory period, a manual breath will *not* be triggered. If there is incomplete exhalation, it will *not* be possible to trigger a manual breath. This is to prevent accidental breath stacking. When operating in CPAP, a breath is delivered using the PIP value from the Apnea Back Up settings.
11. **Rotary Encoder** -- Turn the **ROTARY ENCODER** to change a value or highlight a particular menu option.
12. **Mute/Cancel** -- Press the **MUTE/CANCEL** button to *mute* most Medium Priority alarms, to *cancel/acknowledge* Low Priority alarms, or to *cancel* an action that is no longer desired (for example: a parameter value change). Pressing the **MUTE/CANCEL** button can also be used to cancel any current operation and return to the normal operating screen. The **MUTE/CANCEL** button switch is labeled with a red "X".
13. **Menu** -- Pressing the **MENU** button provides access to user menus and special functions. Use the **ROTARY ENCODER** to scroll to the desired menu option and press the **CONFIRM/SELECT** button to access the menu control. Pressing **CONFIRM/SELECT** then accesses the parameter variable which is changed by turning the **ROTARY ENCODER** to the desired value. To accept the new parameter value, press the **CONFIRM/SELECT**

(the highlight moves from the parameter variable back to the parameter label). For parameters with multiple options, pressing **CONFIRM/SELECT** opens a submenu where the various parameters are selected using the **ROTARY ENCODER** and changed using the process described above. At any point, the operator can cancel an operation, return to the previous menu level, or exit the menu control by pressing the **MUTE/CANCEL** button.

1. **Alarm Configuration** -- allows the operator to disable the audible and visible alarm alerts associated with specific alarm in order to prevent nuisance alarms. While the menu shows all of the alarms that can be disabled, the system only allows you to disable active alarms. This approach assures that the operator has been advised of the alarm and has decided that it does not affect safe and effective management of the patient. It is important to recognize that Low Priority alarms are Advisory and the patient and device are performing as configured, but there is information that could affect management of the patient.

2. **Power Up Settings** -- allows the operator to select startup settings different from the factory defaults. The menu allows the operator to select the current ventilator settings for use at startup. There are 3 options: default, user 1, and user 2. User 1 and user 2 allow the operator to establish different startup settings based on the intended patient population. ZOLL is constantly focused on providing clinically safe, effective and timely support to patients requiring ventilator support as well as ease of use to their care providers. The initial focus and area for application of the unit platform is Acute Patient Care in many varied and austere environments. This patient area of need has historically been the Adult range of patients. ZOLL has used this historical data and experience as its rationale for the unit to start-up in the Adult patient Assist-Control Volume mode and associated parameters which have been deemed as clinically safe and acceptable starting points and limits by international experts and standards committees.

ZOLL also strives to provide user-friendly options to our customers and allow them to set up certain USER Start-up selected modes after their acquisition of the equipment as they know best what their patient base and needs for mechanical ventilatory support are within their respective region or facilities. Realizing that varied levels of need and experience exist, as well as knowing that each patient is different and clinician assessment is required prior to application to the patient, certain mode and parameter configurations are not available as User setup options in an effort to maximize patient safety.

To configure startup settings other than the default, press the **MENU** button, select **POWER UP SETTINGS**; select **SAVE SETTINGS** and select either user 1 or user 2 and press **CONFIRM/SELECT**. To start with the new setting, select **POWER UP WITH** and select which user setting you would like to use at startup and press **CONFIRM/SELECT**. Assure the proper startup setting by turning the ventilator off then on again. The unit will being operation with the new settings. Limits for stored parameters are shown on the table below. Default startup modes are limited to AC and SIMV (SIMV available for EMV+[®] and Eagle II[™] only); CPAP cannot be stored as a stored default.

Parameter	Limitations
V _T Setting	≤1000 ml
V _T High Limit	10ml resolution, only recalled if the target is pressure or in SIMV(V)
V _T Low Limit	10ml resolution, only recalled if the target is pressure or in SIMV(V)
Constant I time vs. constant I:E	No limit

Parameter	Limitations
Target (P or V)	No limit
BPM	6 to 60
BPM High Limit	No limit
BPM Low Limit	>6 bpm
I time	No limit
PIP Target	≤35 cmH ₂ O
PIP High Target	≤35 cmH ₂ O
PIP Low Target	No limit
PEEP	No limit

Caution The operator should set the PIP Low Limit to be at least PEEP + 5. This is to reduce the likelihood of not detecting a kinked hose. If the PIP Low Limit is set > PEEP and < PIP, the PIP Low Limit can also serve as a PEEP compensated disconnect threshold.

3. **Pulse Oximeter** -- allows the operator to turn the pulse oximeter on or place it in standby.
4. **Trigger Lever** -- allows the operator to adjust the assisted breath trigger from -6 to -0.5 cm H₂O to optimize the patient/ventilator interaction; the default value is -2 cm H₂O below baseline. The setting is not retained when the device is powered off.

Caution The operator should take care in setting the trigger level so as to minimize work of breathing and prevent auto-triggering. Ventilating infants and other patients with weak inspiratory effort, the trigger threshold should be reduced (>-2 cm H₂O) to reduce the work required for the patient to trigger a breath. During NPPV with a large leak, the trigger threshold may need to be increased to prevent auto-triggering with the variable baseline pressure.

5. **O₂ Reservoir** -- allows the operator to tell the device that the 3-liter O₂ Reservoir Assembly is in use. Using the reservoir can cause a *Fresh Gas Intake Fault* alarm to occur. Turning this function on disables this alarm and prevents nuisance alarms. The device is still able to detect and alarm if the Fresh Gas/Compressor Intake is blocked and the compressor is not able to deliver its contribution to the breath. Operation in extremely high vibration environments can also trigger this alarm. Using this mode in these situations can reduce nuisance alarms. The setting is not retained when the device is powered off.
6. **Unit Info** -- lists the serial number for the unit and Smart Pneumatic Module (SPM), software version, hours of use, and last calibration date.
 - A. Date: the current date (day/month/year), based on the time and date when the calibration was performed.
 - B. Cal date: displays the date of the last calibration.
 - C. Hours of Op: displays the hours of operation since the last calibration.
 - D. EMV Soft Rev: displays the ZOLL ventilator software revision that is in use with the device.
 - E. EMV SN: displays the serial number of the ZOLL ventilator.
 - F. SPM Soft Rev: displays the SPM software revision that is in use with the device.
 - G. SPM SN: displays the serial number of the SPM.
 - H. EMV Model: displays the model number of the EMV portion of the ZOLL ventilator.

- I. SPM Model: displays the model number of the SPM portion of the ZOLL ventilator.
7. **Contrast** -- allows the operator to adjust the contrast of the LCD to optimize visibility in the current lighting environment. The default is 213; increasing the value increases the contrast while decreasing the value decreases the contrast. During cold weather operation (below 0°C), the contrast can fade. The operator can improve visibility by increasing the contrast. During operation at temperature extremes, the device may start with the display not clearly visible. In these situations, the operator can directly access the contrast control by pressing and holding the Menu and then adjusting the contrast with the **ROTARY ENCODER**.

Display Screen

The LCD parameter windows present information relating to settings, menus/instructions, alarm information, pressure measurement data, pulse oximeter data, and heart rate data. When a parameter, secondary parameter, or alarm limit is associated with an active alarm, the parameter flashes to help the operator better understand the nature of the alarm condition.

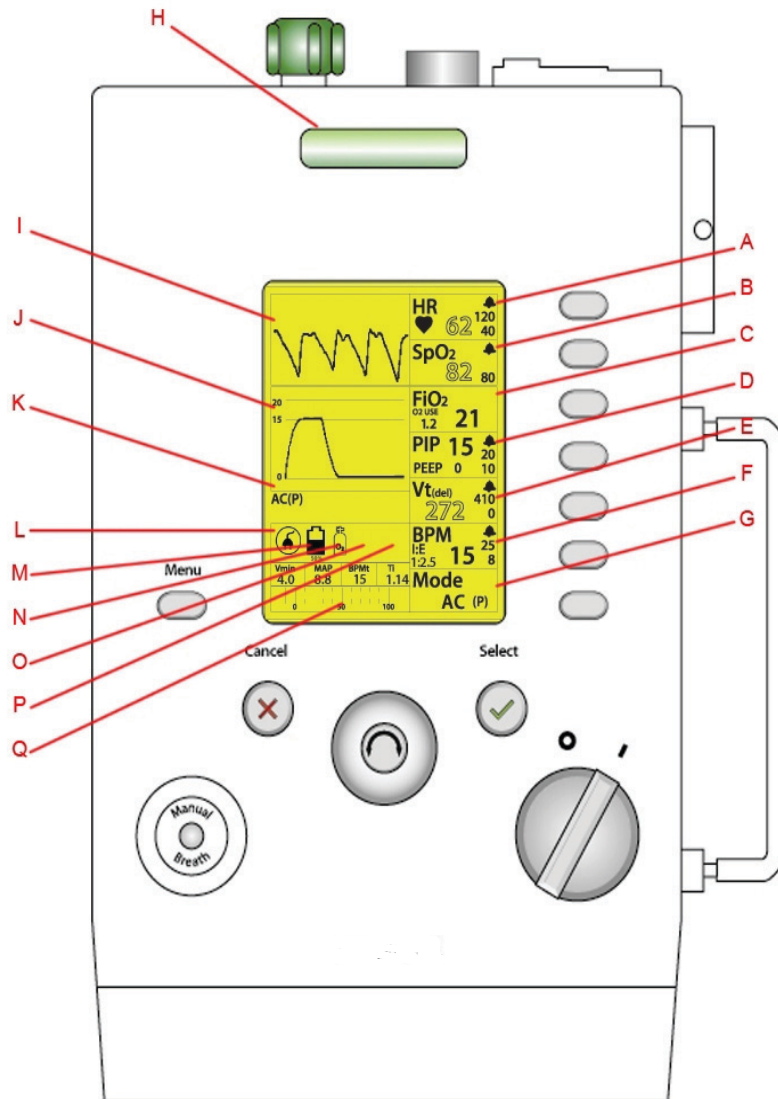

Display Screen

- A. **HR** -- Displays the HR and Low/High HR alarm limits. A heart icon is also displayed in this window when the pulse oximeter is in use. The icon flashes in sequence with the patient's heart rate. Immediately to the left of the HR and SpO₂ parameter windows is the pulse oximeter pleth display. When no alarms are present, the pleth is displayed. When alarms occur, the pleth is removed to allow room for the alarm name and mitigation instructions. When a Low priority alarm is muted, the pleth is returned to the screen. For all priority alarms, the LED indication lights remain active even if the alarm information is not shown on the screen.
- B. **SpO₂** -- Displays the SpO₂ and Low/High SpO₂ alarm limits.

- C. **FIO₂** -- Displays the set fraction of inspired oxygen. The window also displays the O₂ Use value.
- D. **PIP** -- Displays the peak airway pressure, PEEP, and Low/High PIP alarm limits. During volume targeted ventilation, the PIP is displayed as outlined text to remind the operator that it is dependent on the set volume and patient's respiratory mechanics.
- E. **V_T** -- Displays the set tidal volume during volume targeted ventilation. During pressure targeted ventilation, it displays the delivered tidal volume. This is indicated by the outlined text and by displaying (*Del*) next to *V_T*. In pressure targeted ventilation, the Low/High tidal volume alarm limits are displayed.
- F. **BPM** -- Displays the set breath rate, the Low/High breath rate alarm limits, and either the I:E ratio or inspiratory time (depending on the operator configuration). During operation in CPAP, the BPM primary parameter is the patient's actual breathing rate in outlined text.
- G. **Mode** -- Displays the operating mode and the breath target (*V*) for volume or (*P*) for pressure. The upper right corner of this window also displays if the unit is in the NPPV adjunct (Noninvasive Positive Pressure Ventilation) or the default PPV adjunct (Positive Pressure Ventilation).
- H. **Status Indicator LED Array** -- The Status Indicator LED Array contains green, yellow, and red LED's. During normal operation, the Status Indicator LED Array is enabled.
 - **Green** -- Indicates operating power and that all ventilator and patient parameters are operating as intended.
 - **Yellow** -- Indicates that a Low Priority alarm has been detected or that a persistent alarm condition is active. The unit will continue to operate within its safety limits while the yellow LED provides a constant reminder that although it was acknowledged, the condition remains.
 - **Red** -- Indicates High and Medium Priority alarm conditions. The Alarm LED flashes when the alarm occurs. When the **MUTE/CANCEL** button is pushed, the LED illuminates continuously during the 30 seconds that the audible alarm is muted during Medium Priority alarms. Pressing the **MUTE/CANCEL** button during High Priority alarms has no effect.
- I. **Pulse Pleth/Time Plot** -- Displays the pulse pleth waveform if no medium/high priority alarms are displayed.
- J. **Pressure/Time Plot** -- Displays the PIP versus time plot if no medium/high priority alarms are displayed. The numbers indicate the PIP readings, and are not displayed when the PIP is above/below the PIP limits. This pressure information is to assist both in diagnostic evaluation and in setting the rise time.

Note: When no alarms are present, the pulse pleth/time and pressure/time plots are displayed. When alarms occur, the plots are removed to allow room for alarm name and mitigation instructions. When a low priority alarm is muted, the plots are returned to the screen. For all priority alarms, the LED indication lights remain active even if the alarm information is not shown on the main screen.
- K. **Current Mode** -- Displays the current Mode plus any adjuncts that are in effect (for example, CPAP + NPPV, AC(Volume) etc.) The pressure value for the pressure support (PS) is indicated by the number (cm H₂O) in parenthesis after PS (for example, PS (40)).



- L. **External Power Icon/Indicator** -- Indicates the presence of external power. When no external power is sensed, the icon/indicator presents with a diagonal line. If an *External Power Low* or *External Power Fail/Disconnect* alarm occurs, the icon flashes off/on.



- M. **Battery Icon/Indicator** -- Indicates (1) the presence of a functional battery, (2) when the battery is charging, and (3) the current battery capacity. The Battery icon appears in outline form and is filled with horizontal lines indicating its current capacity. When the battery is charging, these horizontal lines cyclically scroll vertically, one row at a time, from the bottom to the top. The scroll rate is faster when the battery is charging faster and it slows down when slower trickle charging. The charge level is indicated numerically under the battery icon. When the battery is fully charged, the icon is completely filled and scrolling stops. Each line represents approximately 5% of battery capacity. During internal battery operations, a horizontal line is removed with each 5% decrement of battery capacity. The Battery icon will flash off/on when a *Battery Power Low* alarm occurs. The icon will flash off/on and present with a diagonal line when no battery is connected.



- N. **Oxygen Supply Icon/Indicator** -- Indicates the presence of external high-pressure oxygen (55 psig source). The icon only appears when high-pressure oxygen is detected by the pressure transducer. The icon flashes off/on when the *Oxygen Low/Fail* alarm occurs.



- O. **Speaker (Mute or Unmute) Icon/Indicator** -- Indicates whether the alarm sound has been muted or is active. The Muted speaker icon is present during the startup 2 minute mute, with the remaining muted time indicated under this icon.



- O. **Head with Mask Icon/Indicator** -- Indicates if the NPPV adjunct is in effect for ventilatory support of spontaneously breathing patients. This icon replaces the Unmuted Speaker and/or the Muted Speaker icon for Low priority alarms. (This icon does not appear if a Medium priority alarm has been muted.)



- P. **Alarm Triangle Icon/Indicator** -- Indicates if there is an active alarm. The priority of the alarm is indicated by the interior of the triangle: empty for Low priority, one exclamation point for Medium priority, and two exclamation points for High priority.
- Q. **Airway Pressure/Measured Values** -- Provides a continuous display of airway pressure. Its absolute range is from -10 to 100 cm H₂O ATPD with a horizontal resolution of 1cm H₂O/pixel. The scale below the indicator is graduated in 10 cm H₂O increments with numerical markers appearing at 0, 50, and 100 cm H₂O. Above the bar graph, measured values for delivered minute volume, mean airway pressure (MAP), and actual breathing rate (set plus spontaneous) are displayed.

Pop Up messages

To prevent setting of unwanted or inadvertent parameter values that are outside the typical clinical range of settings, the unit presents Pop Up messages that ask the operator if they are sure they would like to set the parameter beyond the typical range. When a message occurs, the operator is asked to press the **CONFIRM/SELECT** button before they can adjust a parameter beyond the typical range. Pop Up messages are also used to alert the operator that certain settings are not permitted. In addition, Pop Up messages can call for the operator to **CONFIRM/SELECT** that they are entering configurations where certain alarms are being suppressed, turned “off”, and/or cancelled.

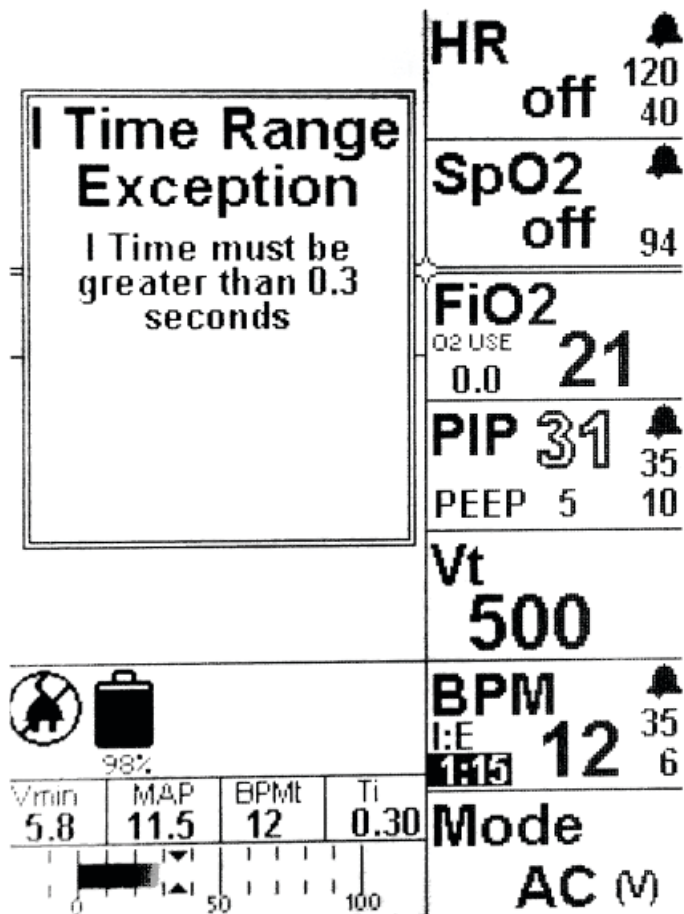

Pop Up Message Example

The following is an alphabetical list of all Pop Up messages and their meaning:

Pop Up Message	Explanation
<i>ALARM DISABLE</i>	Confirmation required-press accept key to disable alarm
<i>BPM LIMIT CONFLICT</i>	Cannot adjust high limit lower than low limit
<i>BPM LIMIT CONFLICT</i>	Cannot adjust low limit higher than high limit
<i>BPM SETTING CONFLICT</i>	I Time cannot exceed 3 seconds
<i>BPM SETTING CONFLICT</i>	I:E > 1:99 not allowed
<i>CPAP + NPPV</i>	Some Alarms Disabled! Configure Alarms for Patient!
<i>HEART RATE LIMIT CONFLICT</i>	Cannot adjust high limit lower than low limit
<i>HEART RATE LIMIT CONFLICT</i>	Cannot adjust low limit higher than high limit
<i>HIGH PRESSURE TARGETING SETTING</i>	Confirmation required-press accept key to exceed 60 cm H ₂ O
<i>HIGH V_T LIMIT SETTING</i>	Confirmation required-press accept key for values above 1500ml
<i>HIGH V_T SETTING</i>	Confirmation required-press accept key to allow V _T > 1000ml
<i>I TIME RANGE EXCEPTION</i>	I Time cannot exceed 3 seconds
<i>I TIME RANGE EXCEPTION</i>	I Time must be greater than 0.3 seconds
<i>I:E RANGE EXCEPTION</i>	I:E > 1:99 not allowed
<i>I:E RANGE EXCEPTION</i>	Inverse I:E not allowed
<i>LOW BREATH RATE SETTING</i>	Confirmation required-press accept key for values below 6 BPM
<i>PEEP BACKUP SETTING CONFLICT</i>	Cannot adjust PEEP target to within 5 of backup PIP target
<i>PEEP SETTING CONFLICT</i>	Cannot adjust PEEP target to within 5 of PIP High Limits
<i>PEEP SETTING CONFLICT</i>	Cannot adjust PEEP target to within 5 of PIP target
<i>PEEP SETTING CONFLICT</i>	PEEP + PS cannot be greater than PIP High Limit
<i>PEEP + PS SETTING CONFLICT</i>	PEEP + PS must be ≥ 3 cm H ₂ O, Adjust Setting to Assure Patient Safety
<i>PIP LIMIT BACKUP SETTING CONFLICT</i>	Cannot adjust high limit lower than backup PIP target
<i>PIP LIMIT CONFLICT</i>	Cannot adjust high limit lower than low limit
<i>PIP LIMIT CONFLICT</i>	Cannot adjust high limit lower than PIP target
<i>PIP LIMIT CONFLICT</i>	Cannot adjust high limit lower than PS + PEEP
<i>PIP LIMIT CONFLICT</i>	Cannot adjust low limit higher than high limit
<i>PIP SETTING CONFLICT</i>	Cannot adjust PIP target higher than PIP High Limit
<i>PIP SETTING CONFLICT</i>	Cannot adjust PIP target to less than 5 more than PEEP

Pop Up Message	Explanation
<i>PS CONFLICT</i>	Cannot adjust PS higher than PIP High Limit - PEEP
<i>REQUESTED COMPRESSOR FLOW TOO HIGH</i>	Cannot exceed 100 LPM total flow
<i>REQUESTED COMPRESSOR FLOW TOO LOW</i>	Reduce FIO ₂ , increase BPM, reduce I Time, or increase V _T
<i>REQUESTED O2 FLOW TOO HIGH</i>	Cannot exceed 100 LPM total flow
<i>REQUESTED O2 FLOW TOO LOW</i>	Reduce FIO ₂ , increase BPM, reduce I Time, or increase V _T
<i>TOTAL REQUESTED FLOW TOO HIGH</i>	Cannot exceed 100 LPM total flow
<i>TOTAL REQUESTED FLOW TOO LOW</i>	Cannot flow less 2 LPM total flow
<i>V_T LIMIT BACKUP SETTING CONFLICT</i>	Cannot adjust high limit lower than Backup V _T Setting
<i>V_T LIMIT BACKUP SETTING CONFLICT</i>	Cannot adjust low limit higher than Backup V _T Setting
<i>V_T LIMIT CONFLICT</i>	Cannot adjust high limit lower than low limit
<i>V_T LIMIT CONFLICT</i>	Cannot adjust high limit lower than V _T Setting
<i>V_T LIMIT CONFLICT</i>	Cannot adjust low limit higher than high limit
<i>V_T LIMIT CONFLICT</i>	Cannot adjust low limit higher than V _T Setting
<i>V_T LIMIT CONFLICT</i>	Cannot adjust V _T Setting above V _T High Limit
<i>V_T LIMIT CONFLICT</i>	Cannot adjust V _T Setting above V _T Low Limit

Set-up

The unit can be configured to suit most applications. Additional hoses, fittings, and adapters may be required for particular uses.

1. For use with external oxygen: connect a green (white for some installations) high-pressure oxygen hose to the OXYGEN IN fitting and a 55 psig external source.
Note: Use only with medical-grade (USP) oxygen. When using with an oxygen cylinder, the cylinder must be secured.
2. Connect the disposable ventilator circuit to the GAS OUTPUT, TRANSDUCER, and EXHALATION VALVE connectors on the unit's Connector Panel. Follow the directions included with the disposable ventilator circuit.
3. In a high-dust or biological environment, a bacterial/viral filter should be attached to the Fresh Gas/Emergency Air Intake to prevent entrainment of particulate or biological matter. (See "Hazard Environment Filters" section.)
4. In toxic biological or chemical environments, the operator can attach a chemical/biological filter to the Fresh Gas/Emergency Air Intake. The threaded interface accommodates chemical/biological filters with an Rd 40 x 1/7 interface (see BS EN 148-1 1999 Respiratory protective devices-threads for face pieces). (For more information, see the "Hazard Environment Filters" section of this manual.)
5. For use with AC power: connect the AC/DC Power Supply (supplied) to the External Power Input.
Note: The unit can operate from internal batteries or from external AC or DC power sources.

Warning! Always assure that there is an alternate means of providing ventilation. A bag-valve resuscitator and an appropriate mask for the patient being ventilated should be immediately available.

Warning! This unit's USB connection does not provide any signal output or input to the operator. It is for the use of ZOLL-trained personnel only. The operator should not connect anything to the USB connection.

External Gas Sources

The unit can operate using high-pressure oxygen from either oxygen cylinders or piped oxygen sources, as illustrated below:

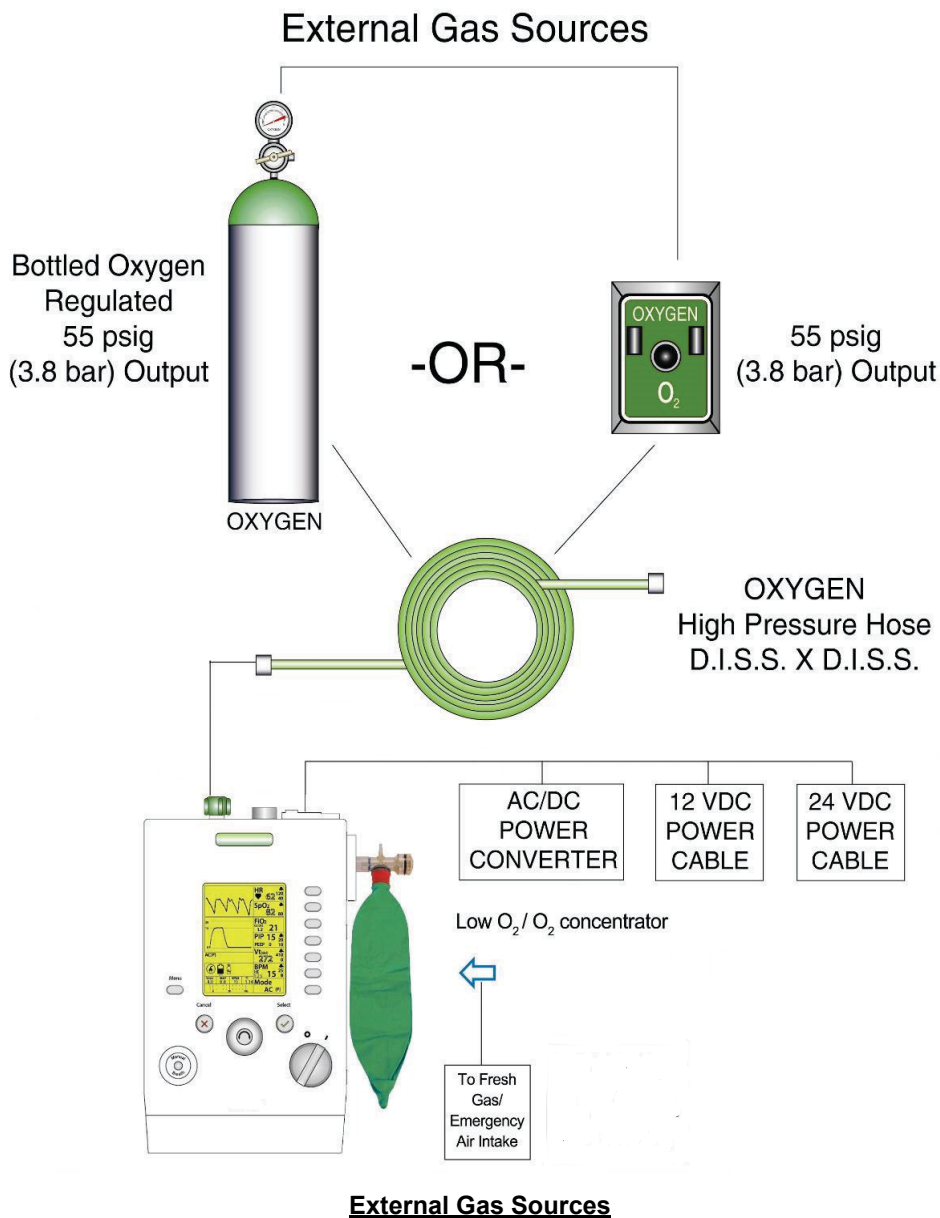

The duration of use for a gas cylinder depends on the size and pressure of the cylinder, and the rate at which gas is being used to support the patient. The formula to calculate the operating duration of any cylinder (based on the Ideal Gas Law) is given below. An example is worked out for a typical large cylinder. It is recommended that the gas cylinder pressure not be allowed to fall below 300 psi.

$V_{\text{start}} = 9540$ liter at 1 atm/ 70F (21C): from label on cylinder

$P_{\text{start}} = 2640$ psig: from label on cylinder

$P_{\text{present in cylinder}} = 300$ psig: from pressure gauge on cylinder

$V_{\text{present in cylinder}} = \text{volume remaining in cylinder} = (P_{\text{present}} / P_{\text{start}}) V_{\text{start}} = 1084$ liter at 1 atm/ 70°F (21°C)

$V_{\text{delivered}} = 9540 - 1084 = 8456$ liter at 1 atm/ 70°F (21°C)

For a typical ventilator setting (20 BPM, $V_T = 500$ ml, $FIO_2 = 100\%$, I time = 1 sec, I:E = 1:2:0), the gas consumption is 10 liter/min.

Note: Whenever external high-pressure oxygen is used, the unit automatically determines the oxygen usage and displays it in the FIO_2 parameter window. (See O_2 Use under FIO_2 in “Description of Controls and Display.”)

Total duration of the gas cylinder in the above example = $V_{\text{delivered}} / (10 \text{ liter/min}) = 8456 / 10 \text{ min} = \sim 14$ hours.

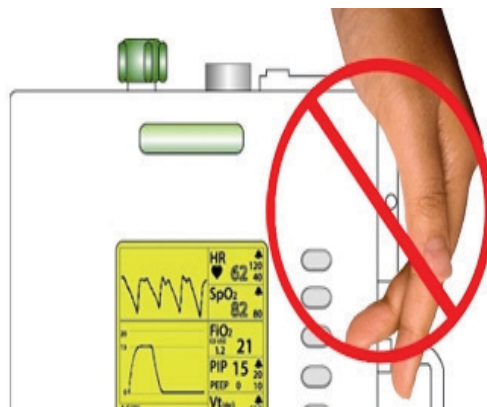

Fresh Gas/Emergency Air Intake

Warning! Never block the Fresh Gas/Emergency Air Intake. A free flow of air is required during compressor operation or in the event of a device failure to allow spontaneous breathing. The Fresh Gas/Emergency Air Intake also acts as an anti-asphyxia port in the event of a ventilator failure.

Ventilator Circuits: Connections

The unit is designed to operate using a standard disposable ventilator circuit. The circuit is attached to the ventilator as shown below:

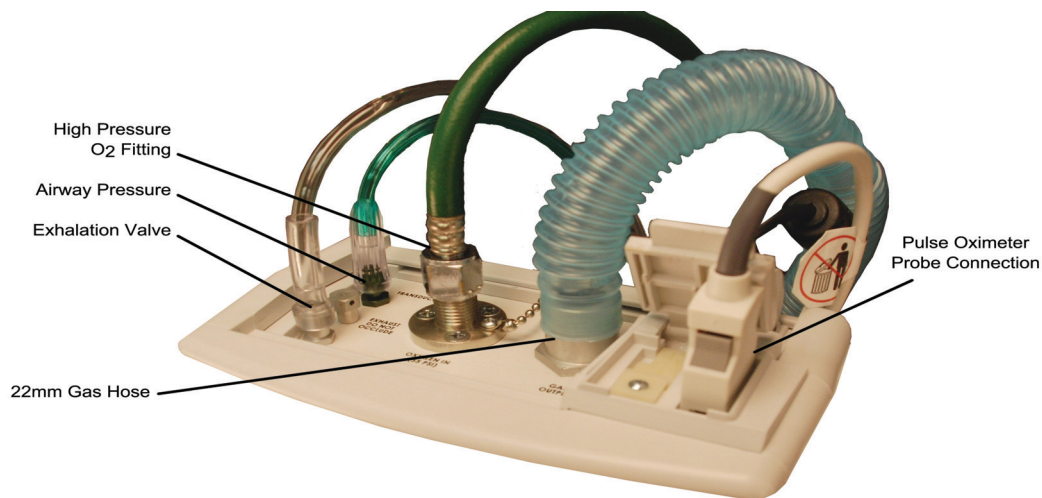

Ventilator Circuit Device Connections

Caution Always dispose of the circuit after single patient use following the institutional guidelines for biologically contaminated material. Reusing the circuit can result in cross contamination between patients.

Ventilator Circuits: Patient Connections

The unit uses two different single limb vent non-MRI circuits to support patients from ≥ 5 kg to adult: Infant/Pediatric (Part #820-0107-00) and Pediatric/Adult (Part #820-0106-00). Similar circuits (differing only in hose length) are available for use in an MRI environment: Infant/Pediatric (Part #820-0131-00) and Pediatric/Adult (Part #820-0130-00). The circuits are illustrated below:

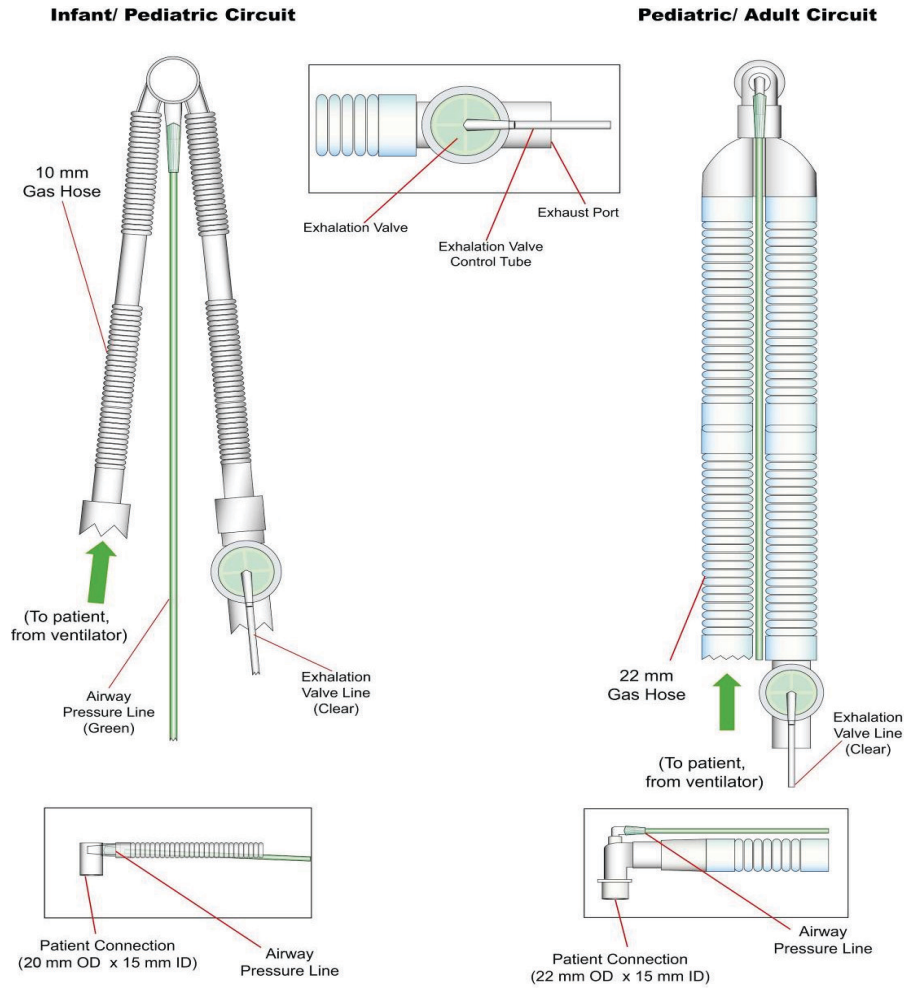

Ventilator Circuit, Patient Connections

Ventilator Circuits: Resistance, Compliance, and Deadspace

Appropriate ventilation depends on the patient lung volume, which is related to the patient weight. Based on Ventilation Standards, patients are divided into three categories (Infant, Pediatric, and Adult). The details of these patient categories and the Flow required by regulations for Resistance measurement are indicated in the following table:

Patient	Patient Weight (kg)	Resistance measured at Flow (l/min)
Adult	≥ 40	60
Pediatric	12-50	30
Infant	5-12	5

ZOLL provides four ventilator circuits depending on patient size and longer length required for MRI operation, as indicated in the following table:

Ventilation Circuit	ZOLL Part Number	Warning!	Dead Space (ml)
Pediatric/Adult	#820-0106-00	<u>Do not use on Infant patients.</u>	17
Pediatric/Adult-MRI	#820-0130-00	<u>Do not use on Infant patients.</u>	17
Infant/Pediatric	#820-0107-00	<u>Do not use on Adult patients.</u>	4.2
Infant/Pediatric-MRI	#820-0131-00	<u>Do not use on Adult patients.</u>	4.2

Warning! Adult patients should only be ventilated with Pediatric/Adult circuits. Infant patients should only be ventilated with Infant/Pediatric circuits.

Pediatric patients can be ventilated with either the Pediatric/Adult or Infant/Pediatric circuits. However, ventilation of Pediatric patients in the higher weight range (30-40 kg) with Infant/Pediatric circuits requires gas flows that result in noisy operation. There is no patient risk to this noise, except that it could disturb the patient and distract the operator. To avoid this noise, the recommended Pediatric patient weight ranges for use with the various circuits, and the corresponding Resistance and Compliance measurements, are indicated in the following table:

Standard Circuit Length					
Patient	Recommended Patient Weight (kg)	Breathing Circuit	Inspiratory Resistance (cm H ₂ O)	Expiratory Resistance (cm H ₂ O)	Compliance (ml/cm H ₂ O)
Adult	≥ 40	Pediatric/Adult	1.44	4.82	1.2
Pediatric	12-50	Pediatric/Adult	0.39	2.99	1.2
Pediatric	12-30	Infant/Pediatric	5.99	5.21	0.44
Infant	5-12	Infant/Pediatric	0.24	1.78	0.44

MRI Longer Circuit Length					
Patient	Recommended Patient Weight (kg)	Breathing Circuit	Inspiratory Resistance (cm H ₂ O)	Expiratory Resistance (cm H ₂ O)	Compliance (ml/cm H ₂ O)
Adult	≥ 40	Pediatric/Adult	2.33	4.44	2.1
Pediatric	12-50	Pediatric/Adult	0.65	2.63	2.1
Pediatric	12-30	Infant/Pediatric	1.28	1.75	0.75
Infant	5-12	Infant/Pediatric	0.39	1.25	0.75

Warning! If circuits with different resistance/compliance are used or additional adjuncts are placed in line with the circuit, the operator must make sure that the appropriate circuit resistance/compliance factors for the new circuit are used as well as dead space volume of the added adjunct(s) is/are factored into the equation for effective tidal volume delivery to the patient.

Operating Power Selection and Stopping

The **POWER** switch is the master power switch. Use this switch to indicate or end operation. The unit is designed to operate using any one of three power sources:

1. Internal 14.8V lithium ion (Li Ion) rechargeable battery with 6.6 Ah capacity (fully charged, the battery provides 10 hours of operation at factory default settings with pulse oximeter operating at 25C).
2. External AC/DC Power Supply (110-240 VAC 50/60 and 400 Hz--ZOLL verified testing, and 110-240 VAC 50/60--SGS listed) with IEC 320 style AC input connector (supplied). The AC/DC Power Supply provides a DC output of 24V at 4.2A.
3. External DC power from a standard vehicle DC outlet using the 12 or 28 VDC Power Cables. The input connector of the EMV+ is designed to accept DC voltages between 12.5 to 28.0 VDC +/- 10% volts, negative ground.

Caution When using the standard vehicle DC outlet, the vehicle should not be jump started during operation of the ventilator.

Warning! Never start the ventilator with the patient connected. Always start the ventilator, select the patient settings, ensure operation, and then connect the patient. Always manually ventilate the patient when they are not connected to the ventilator.

The unit is designed to use external power when available rather than its internal battery pack. When an acceptable external power source is present, the internal battery pack is automatically charged while the unit operates. When an external power failure occurs, the unit automatically switches to its internal battery pack for operating power and activates the *EXTERNAL POWER FAILURE* alarm; there is no interruption in operation and/or loss of any alarms. When external power returns, operating power automatically switches from internal power to the external source. In the event that the device needs to be shutdown, the procedure consists of turning the **POWER** switch to the OFF (“O”) position. If this fails to work or puts the patient or operator at possible risk, the device should be disconnected for the mains power.

Power Supply Connections

The following illustration demonstrates how to properly connect the external power cable.

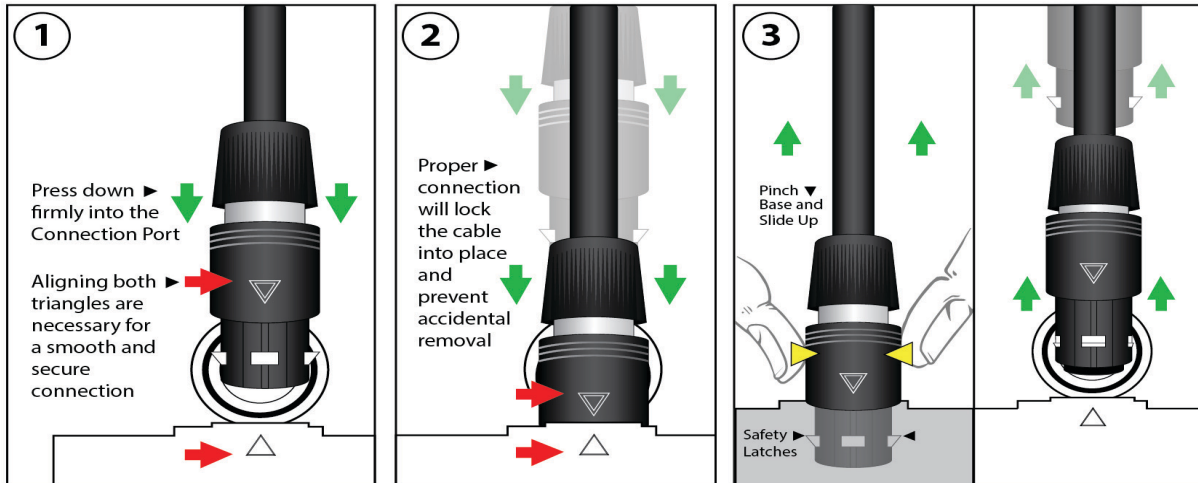

Firmly insert the power supply plug into the connection port with the triangles aligned for a secure connection.

Give a firm tug to assure power supply plug has been connected correctly and is locked into control panel.

Pinch the plug at the base and slide up to release the safety latches to remove the plug from the control panel.

Connecting and Disconnecting the Power Supply

Caution Do not twist the power cable connection plug. Pinch the plug and slide up to release the safety latches. Failure to do so may damage the power connection plug and prevent it from functioning.

Warning! If the power supply, power cable, or power connection plugs are damaged or become damaged during use, immediately disconnect the power cable from external power and the power supply assembly.

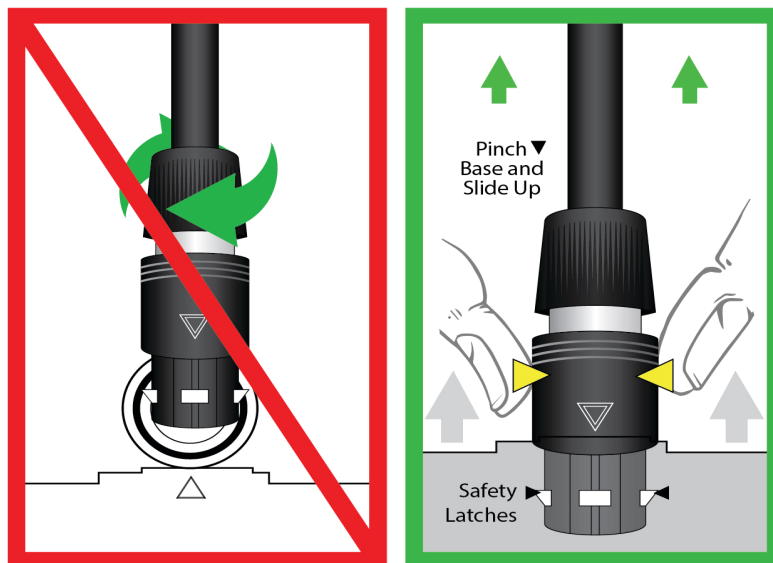

Power Supply Latching

Self-Check

At start up, the unit automatically performs a self-check that includes a check for pre-existing alarm conditions. Following start up, the presence of alarm conditions is checked continuously. The ventilator circuit must be open to ambient atmosphere (not connected to the patient) during start up. Ventilator operation begins immediately following the self-check.

Warning! **Until the operator has determined that the ventilator is functioning properly and that the ventilator parameters are set correctly for the patient, the patient should not be connected to the ventilator.**

Transducer Calibration (AUTO CAL)

The AUTO CAL affects 3 transducer systems: Compressor Flow, Oxygen Flow, and Airway Pressure. Its purpose is to compensate for small temperature related drifts in the transducer offset (zeroing). The AUTO CAL is performed during self-check, and then every 5 minutes thereafter. However, if a temperature change exceeding +/- 1.5°C is sensed, the AUTO CAL time interval is reduced automatically to assure a stable pressure measurement baseline.

Pulse Oximeter Principles

The Masimo SET[®] MS board pulse oximeter is based on three principles:

1. Oxyhemoglobin and deoxyhemoglobin differ in their absorption of red and infrared light (spectrophotometer).
2. The volume of arterial blood in tissue and the light absorbed by the blood changes during the pulse (plethysmography).
3. Arterio-venous shunting is highly variable and that fluctuating absorbance by venous blood is a major component of noise during the pulse.

The Masimo SET MS board pulse oximeter as well as traditional pulse oximetry determines SpO₂ by passing red and infrared light into a capillary bed and measuring changes in light absorption during the pulsatile cycle. Red and infrared light-emitting diodes (LEDs) in oximetry sensors serve as the light sources, a photodiode serves as the photodetector.

Traditional pulse oximetry assumes that all pulsations in the light absorbance are caused by oscillations in the arterial blood volume. This assumes that the blood flow in the region of the sensor passes entirely through the capillary bed rather than through any arterio-venous shunts. The traditional pulse oximeter calculates the ratio of pulsatile absorbance (AC) to the mean absorbance (DC) at each of two wavelengths, 660 nm and 905 nm:

$$S(660) = AC(660)/DC(660)$$

$$S(905) = AC(905)/DC(905)$$

The oximeter then calculates the ratio of these two arterial pulse-added absorbance signals:

$$R = S(660)/S(905)$$

This value of R is used to find the saturation SpO₂ in a look-up table built into the oximeter's software. The values in the look-up table are based upon human blood studies against a laboratory co-oximeter on healthy adult volunteers in induced hypoxia studies.

The Masimo SET MS board pulse oximeter assumes that arterio-venous shunting is highly variable and that fluctuating absorbance by venous blood is the major component of noise during the pulse. The MS board decomposes S(660) and S(905) into an arterial signal plus a noise component and calculates the ratio of the arterial signals without the noise:

$$S(660) = S1 + N1$$

$$S(905) = S2 + N2$$

$$R = S1/S2$$

Again, R is the ratio of two arterial pulse-added absorbance signals and its value is used to find the saturation SpO₂ in an empirically derived equation into the oximeter's software. The values in the empirically derived equation are based upon human blood studies against a laboratory co-oximeter on healthy adult volunteers in induced hypoxia studies.

The above equations are combined and a noise reference (N') is determined:

$$N' = S(660) - S(905) \times R$$

If there is no noise, N' = 0: then S(660) = S(905) x R, which is the same relationship for traditional pulse oximeter.

The equation for the noise reference is based on the value of R, the value being sought to determine the SpO₂. The MS board software sweeps through possible values of R that correspond to SpO₂ values between 1% and 100% and generates an N' value for each of these R-values. The S(660) and S(905) signals are processed with each possible N' noise reference through an adaptive correlation canceler (ACC), which yields an output power for each possible value of R (i.e., each possible SpO₂ from 1% to 100%). The result is a Discrete

Saturation Transform (DST™) plot of relative output power versus possible SpO₂ value as shown in the following figure where R corresponds to SpO₂ = 97%:

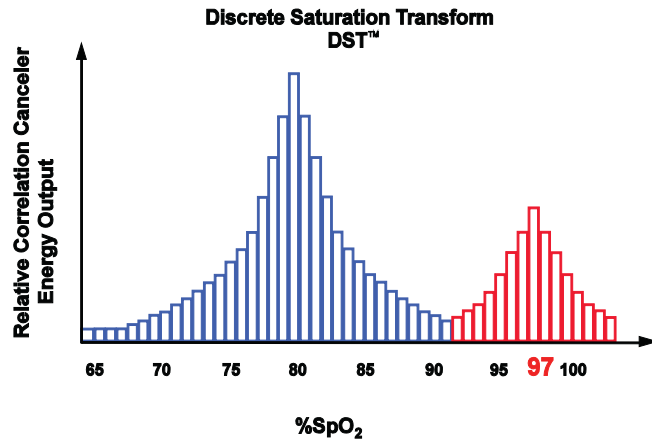

Pulse Oximeter Discrete Saturation Transformation

The DST plot has two peaks: the peak corresponding to the higher saturation is selected as the SpO₂ value. This entire sequence is repeated once every two seconds on the most recent four seconds of raw data. The MS board SpO₂ therefore corresponds to a running average of arterial hemoglobin that is updated every two seconds.

Chapter 3

Operation

Overview

Introduction

The ZOLL ventilator is a volume and pressure targeted, time or flow cycled ventilator designed to use either oxygen from a 55 psig source or fresh air using its internal compressor to deliver a positive pressure breath. The user interface allows the operator to initiate the unit at default setting values.

When high-pressure oxygen is connected, the internal blender allows the FIO₂ to be set from 21 to 100%. Backpressure from the patient connection does not affect the delivered accuracy of the volume, flow, pressure, or FIO₂. When the FIO₂ is set to 21%, operators may connect a low flow oxygen source at the Fresh Gas/Emergency Air Intake using the reservoir (See “Use of Low Flow Oxygen” section). A suite of alarms alert the operator when conditions exceed parameter limits or when operation is affected by an external or internal fault or failure. When an alarm occurs, the operator is alerted by audible and visual indicators while context sensitive help messages are displayed in the LCD’s Alarm Message Center. Operating power is from an external AC/DC power converter connected to live AC mains, external DC power, or from the internal rechargeable lithium ion battery. Fresh air is filtered using a particulate filter or, when the operating environment requires, a bacterial/viral filter or a chemical/biological filter may be attached.

When the unit is first powered up, certain patient circuit alarms are preemptively muted for 120 seconds, to allow the operator time to attach the patient circuit, pulse oximeter, and properly adjust the ventilator without nuisance alarms. For a list of these preemptively muted alarms, see the “Alarms Turn Off & Cancellation” section. The time remaining for the mute period is displayed on a countdown clock shown beneath the speaker icon.

Pulse Oximeter

At start up, the pulse oximeter is in standby (pulse oximeter on and ready to monitor) and the parameter windows for SpO₂ and Heart Rate read *stby* and operational alarms are suppressed. As soon as a valid patient signal is detected ≥ 10 seconds, the pulse oximeter comes out of standby, a pulse search is performed to obtain the optimum signal and then the parameters are displayed, and all alarms are active. The pulse oximeter can be turned on via the “Pulse Oximeter” submenu in the main menu by changing *stby* to *On*. Similarly, if the probe is removed from the patient and monitoring is no longer desired, the pulse oximeter can be placed back in standby via the “Pulse Oximeter” menu submenu. See the “Pulse Oximeter Principles” section and the “Pulse Oximeter” section of “Specifications”.

The pulse oximeter and its accessory probes and cables are intended for continuous noninvasive monitoring of arterial hemoglobin (SpO₂) and pulse rate (measured by the SpO₂ sensor) for adult, pediatric and infant patients using the appropriate sensor for the patient. The pulse oximeter is operational in all ventilator modes when its cable and sensor are properly attached to the SpO₂ connector.

To operate the pulse oximeter, connect the probe to the patient cable and the patient cable to the SpO₂ connector on the unit. The monitoring function will continuously display the patient’s pulse rate and SpO₂ value. See the Pulse Oximeter Alarms in the Ventilator Alarm Categories section for more information on pulse oximeter alarms.

Note: The pulse oximeter can only be placed in standby when the probe is disconnected from the patient. A valid signal will automatically bring the pulse oximeter out of standby.

The pulse oximeter reading can be affected by the following conditions:

1. The sensor is too tight.
2. There is excessive illumination from light sources such as a surgical lamp, a bilirubin lamp, or sunlight.
3. A blood pressure cuff is inflated on the same extremity as the one with a SpO₂ sensor attached.
4. The patient has hypotension, severe vasoconstriction, severe anemia, or hypothermia.
5. There is an arterial occlusion proximal to the sensor.
6. The patient is in cardiac arrest or is in shock.

Operation

The unit has been designed to ease the learning transition commonly associated with new equipment. Turning the **POWER** switch to “1” starts an internal Self Check and begins operation with the default settings. The operator has the option of delivering volume targeted or pressure targeted breaths. An internal blender enables the unit to deliver oxygen concentrations from 21 to 100% using its internal compressor and/or a standard medical-grade oxygen source. Additionally, low-pressure oxygen can be entrained through the Fresh Gas/Compressor Intake using the reservoir accessory except when a chemical/biological filter is connected. When using the reservoir, the FIO₂ should be set to 21% and enable the O₂ Reservoir mode from the User Menu (enabling this avoids nuisance alarms from the compressor inlet sensors). The operator should titrate the flow of oxygen to the reservoir to maintain an adequate SpO₂ value. O₂ Reservoir mode is indicated on the display with a plus “+” sign next to the FIO₂ value.

Modes of Operation

The unit offers a range of modes using both pressure and volume targeting that can be selected to optimally manage the patient.

Assist/Control (AC) -- The patient receives either controlled or assisted breaths. When the patient triggers an assisted breath, they receive a breath based on either the volume or pressure target.

Synchronized Intermittent Mandatory Ventilation (SIMV) -- The patient receives controlled breaths based on the set breathing rate. Spontaneous breaths can be either unsupported demand flow or supported using Pressure Support. (This mode is not available in the AEV[®] unit.)

Continuous Positive Airway Pressure (CPAP) -- The patient receives constant positive airway pressure while breathing spontaneously. Spontaneous breaths can be either demand flow or supported using Pressure Support.

EMV+[®], Eagle II[™]: The default CPAP provides positive end-respiratory pressure with and without Pressure Support. The operator has the option of adding leak compensation (NPPV) if desired to support the patient. The minimum baseline pressure (PEEP) in CPAP-NPPV is 3 cm H₂O regardless of the Pressure Support setting.

AEV[®]: Only provides for CPAP with leak compensation (NPPV) with or without Pressure Support. The minimum baseline pressure (PEEP) in CPAP-NPPV is 3 cm H₂O regardless of the Pressure Support setting.

Note: In the SIMV(P), SIMV(V), and CPAP modes, the sum (PEEP + PS) must be ≥ 3 cm H₂O.

Note: In transitioning from AC to either CPAP or SIMV, if the starting PEEP value is 3 cm H₂O or less, the PEEP shall be set to 3.0 cm H₂O during the transition. (This is to assure that there is never a situation when both the PS and PEEP are zero, which would violate (PEEP + PS) ≥ 3 cm H₂O.)

Note: Negative pressure is not available in the expiratory phase.

Additional Adjuncts of Operation

In addition to Modes of Operation, the unit also provides various adjuncts that can be used to manage the patient. Two adjuncts are Pressure Support (PS) and Noninvasive Positive Pressure Ventilation (NPPV). The following table shows which adjuncts can be used with which modes. It is possible to use more than one adjunct, if the mode permits.

Mode	Breath Target	Pressure Support (PS)	Noninvasive Positive Pressure Ventilation (NPPV)
AC	V & P	No	No
SIMV	V & P	Yes	No (SIMV is not available in AEV [®])
CPAP	N/A	Yes	Yes (CPAP-NPPV is Automatic in AEV [®])

Pressure Support (PS) -- Can be used to assist spontaneous breaths in both SIMV and CPAP modes. To set pressure support, press and hold the **PIP** parameter button (while the mode is set to either SIMV or CPAP), press the **CONFIRM/SELECT** button to highlight the PS value, then turn the **ROTARY ENCODER** to the desired value. Once the desired value is selected, press the **CONFIRM/SELECT** button to enable the value and then the **MUTE/CANCEL** button to return to the main screen. The Current Mode display will denote the value of this pressure support by the number (cm H₂O) in parenthesis after PS (value).

Noninvasive Positive Pressure Ventilation (NPPV) -- Provides flow during the expiratory phase to maintain the baseline pressure (CPAP) in spontaneously breathing patients with a leaking airway or facemask. The amount of leak compensation depends on the leak flow rate during the expiratory period and ranges from 0 to 15 liters/min and is automatically adjusted by the ventilator in order to maintain the CPAP target. In the AEV[®] model, the NPPV is automatically in place when the CPAP mode is entered.

Caution The operator should take care in setting the V_T alarms and trigger level. The trigger level should be adjusted to minimize work of breathing and prevent auto-triggering. The V_T alarms should bracket average tidal volume so that pending respiratory failure (low tidal volumes) and excessive leaks (high tidal volumes) are detected.

Caution The transition into NPPV automatically sets the rise time to 3, which may be too fast for infants and small children. Before using with an infant or small child, the operator should always configure the ventilator appropriately before attaching the patient.

Warning! **In CPAP-NPPV, a V_T that is lower than anticipated given the patient's size may be an indication that the patient is not able to adequately spontaneously ventilate.**

To avoid nuisance alarms in patients with active leaks, operation using NPPV suppresses certain alarms. The alarms which are suppressed are:

1. Incomplete Exhalation (Alarm #3091)
2. Insufficient Flow (Alarm #2095)

To start NPPV in either EMV+[®] and/or Eagle II[™]:

1. Press **MODE** button to highlight mode.
2. Select CPAP and press **Accept**.
3. Press **MODE** button until the **PPV** field is selected.
4. Adjust to NPPV.

5. Pop Up message will appear and ask for confirmation.
6. Press **Accept**.
7. Once the patient has reached steady state, the alarms should be configured to closely monitor the patient.

To start NPPV in AEV[®]:

1. Press **MODE** button to highlight mode.
2. Adjust to CPAP.
3. Pop Up message will appear and ask for confirmation.
4. Press **Accept**.
5. Once the patient has reached steady state, the alarms should be configured to closely monitor the patient.



When the NPPV adjunct is in operation, the head with mask icon will appear in the location used by the speaker/mute icons. Low and Medium priority alarms will cause this head with mask icon to disappear. It will reappear when Low priority alarms are muted. When Medium priority alarms are muted, the muted speaker icon will appear.

When transitioning to NPPV mode, the following parameters/alarm limits will automatically be adjusted to the following default values:

Alarm/Parameter	CPAP into NPPV Default Value
High BPM Alarm	40
Low BPM Alarm	4
Low Airway Pressure Alarm	Off
PEEP	5 cm H ₂ O
V _T High Limit	Off
V _T Low Limit	Off
Rise Time	3
Pressure Support	2 cm H ₂ O

When transitioning from the NPPV mode to another mode, the following parameters/alarm limits will reset to the default values. This is done to assure appropriate monitoring in an active ventilating mode:

Alarm/Parameter	NPPV into CPAP Default Value	NPPV to P Default Value
High BPM Alarm	25	25
Low BPM Alarm	8	8
Low Airway Pressure Alarm	(PIP Target = -3)	(PIP Target = -3)
PEEP	No change	No change
V _T High Limit	750	750

Alarm/Parameter	NPPV into CPAP Default Value	NPPV to P Default Value
V _T Low Limit	250	250
Rise Time	No change	No change
Pressure Support	No change	If ACP, Pressure Support = 0

Warning! Never use the CPAP with or without Noninvasive Positive Pressure Ventilation (NPPV) adjunct on a patient that is NOT spontaneously breathing and/or may stop spontaneously breathing. CPAP is intended for *ventilatory support*, NOT *ventilation*.

Spontaneous/Assisted Breath Trigger

The Spontaneous/Assisted Breath Trigger is preset to -2.0 cm H₂O and can be adjusted from -6.0 to -0.5 cm H₂O below the baseline (PEEP) pressure. In order to initiate a spontaneous or assisted breath, the patient must generate -2.0 cm H₂O. When the pressure drop is detected, an assisted breath is delivered. The trigger value can be adjusted in the User Menu.

Operational Test Procedure

Before attaching the patient to the ventilator, the operator should perform an Operational Test to ensure that the breathing circuit is properly attached and that the primary patient safety alarms (*PATIENT DISCONNECT*, *HIGH AIRWAY PRESSURE LIMIT*) are functioning properly. The test should be performed following connection of the breathing circuit.

Procedure:

1. With the breathing circuit connected, turn the **POWER** switch to *ON*, to allow the ventilator to complete Self Check and begin operation with its default values.
2. The *PATIENT DISCONNECT* alarm should be active. (The audible alarm will be muted during the 2 minute initial mute.)
3. Press the **MANUAL BREATH** button; gas should flow out of the patient connection each time the button is pressed.

Note: The minimum period between manual breaths is limited by the tidal volume and the time required to complete a full exhalation based on the I:E ratio.)

4. Close the patient port with a clean hand or gloved hand. During inspiratory phase, the *HIGH AIRWAY PRESSURE LIMIT* alarm should activate after 2 breaths that reach the PIP High Limit.
5. If the *HIGH AIRWAY PRESSURE LIMIT* alarm fails to activate, ensure that all of the tubing connections are secure, the exhalation valve is closing during inhalation, and that the High Airway Pressure Limit is set to 35 cm H₂O or less.
6. After a breath or two, release the patient port while allowing the ventilator to operate. The *PATIENT DISCONNECT* alarm should activate.
7. Partially close the patient port to reset the *PATIENT DISCONNECT* alarm. With no other alarms occurring, remove external power from the ventilator. The *EXTERNAL POWER LOW/DISCONNECT* alarms should activate. Reconnect external power to reset alarms.

8. If either the *HIGH AIRWAY PRESSURE*, *PATIENT DISCONNECT*, or *EXTERNAL POWER LOW/DISCONNECT* alarms fail to activate, continue to manually ventilate the patient, replace the ventilator, and send the unit in for service.
9. If operating using the internal battery, verify that the Battery icon indicates sufficient available battery capacity remains to support the anticipated duration of operation. If not, begin ventilation and find an alternate source of power.

Note: The trigger automatically adjusts when the PEEP is changed.

To Begin Ventilating

Procedure:

1. Attach the disposable patient circuit to the ventilator. If you wish to use a Heat and Moisture Exchanger (HME), attach it to the patient connector of the ventilator circuit.
2. Attach the AC/DC Converter to an appropriate AC power source if available.
3. Turn the **POWER** switch on to initiate the Self Check and start the ventilator. When Self Check is complete, operation will begin at default values.

Parameter	Mode	BPM	V _T	PEEP	FIO ₂	I:E	High PIP Limit
Default Value	AC(V) ^a	12	500 ml	5 cm H ₂ O	21% ^b	1:2.5	35 cm H ₂ O

a. (V): indicates volume targeted ventilation

b. If external oxygen is attached, the default FIO₂ will be 100%

Warning! **Default settings are intended to provide basic support and prevent unintended injury. Particular care should be taken to adjust the ventilator appropriately before ventilating infants and children. The ventilator should always be adjusted before placing the patient on the ventilator.**

4. Allow at least one breath to occur; during this time, the *PATIENT DISCONNECT* alarm will activate as the ventilator does not detect the minimum required airway passage.
5. Attach the ventilator circuit connector¹ to the patient's endotracheal tube, tracheostomy tube, or other airway that supports positive pressure ventilation². Delivery of the first breath will automatically cancel the *PATIENT DISCONNECT* alarm.

Warning! **During noninvasive ventilation, NEVER LEAVE THE PATIENT UNATTENDED!**

Warning! **Avoid high airway pressure as this increases the risk of aspiration.**

Warning! **Deadspace increases with mask ventilation; always follow the mask manufacturer's directions.**

1. 22 mm OD/15 mm ID standard conical interface for use with respirator devices.

2. Other airways can include: laryngeal mask airway, esophageal obturator airway, and combination esophageal-tracheal tubes though their use should be under the direction of the attending physician. See AARC Clinical Practice Guideline, Management of Airway Emergencies Respiratory Care 1995;40(7): 749-760 Section 10.2.2.

Warning! During pressure-targeted ventilation, always set the high tidal volume just above the patient's maximum tidal volume. In the event of disconnection or decannulation, the alarm will activate indicating more volume is required to reach the set pressure target.

6. Once connected to the ventilator, carefully assess the following:
 - a. Attach the pulse oximeter probe and begin monitoring HR and SpO₂ (See instructions provided with the pulse oximeter)³.
 - b. Set the high and low HR alarms appropriately for the patient.
 - c. Set the low SpO₂ limit appropriately for the patient.
 - d. Assess the patient's breath sounds for bilateral ventilation.
 - e. If this is not possible, watch the rise and fall of the chest wall to determine if there is adequate movement on both sides of the chest.
 - f. Check Airway Pressure indicator to determine the peak airway pressure. Set the high and low airway pressure limits 5 to 10 cm H₂O above/below the peak pressure. This will prevent excess airway pressure and leaks.
 - g. Set the high and low tidal volume alarms and breathing rate during pressure-targeted breathing.
-

Warning! Always set the Low Airway Pressure Limit at least 5 cm H₂O above PEEP. Ideally, the value should be 5 cm H₂O < PIP.

7. Start a record of the date, time, ventilator settings, power source, and patient status.
 8. Check the patient and ventilator on a regular basis to assure adequate ventilation and device performance. Listen for, and respond to, all alarms.
 9. During transport, reassess the patient and ventilator at least every hour or whenever the patient is moved. When operating on battery power, always monitor the battery charge.
-

Warning! Do not leave the patient unattended.

To Change Settings

Each Parameter button of the unit is associated with a parameter window; each parameter window has a primary parameter and as many as 3 secondary parameters that can be adjusted by the operator based on the mode of operation and breath target. To adjust the primary parameter, press the Parameter button one time; to adjust a secondary parameter, press the Parameter button a second or third time. Each time you press the Parameter button, a different parameter is highlighted in the parameter window. To change a primary or secondary parameter, use the following sequence:

1. Press the Parameter button one or more times to select either the primary parameter or secondary parameters.
2. With the appropriate parameter highlighted, turn the **ROTARY ENCODER** clockwise or counterclockwise to raise or lower the value.
3. Press the **CONFIRM/SELECT** button switch “**V**” to complete the value change.

-
3. If the accuracy of any measurements does not seem reasonable, first check the patient's vital signs by alternate means and then check the pulse oximeter for proper functioning.

-
4. At any time, the operator can exit from any operation by pressing the **MUTE/CANCEL** button “**X**”.

Examples

Example 1-To change the ventilation rate from 12 to 16:

Step 1: Press the BPM button once.

Step 2: Turn the Rotary Encoder clockwise to 16.

Step 3: Press the Confirm/Select button.

Example 2-To change from volume targeted breaths to pressure targeted breaths:

Step 1: Press the Mode parameter twice.

Step 2: Turn the Rotary Encoder clockwise to switch from “(V)” volume to “(P)” pressure.

Step 3: Press the Confirm/Select button.

Back Up Ventilator

The unit contains a built-in back up ventilator mode that is designed to provide a limited degree of operation should certain types of failures occur to the primary operating system. Depending upon the pre-existing conditions at the time of failure, the backup ventilator will begin operation in one of two ways:

1. If no pre-existing alarm condition(s) exists: backup operation will continue using the current settings.
2. If a pre-existing alarm condition(s) exists: backup operation will revert to the startup default settings (Mode AC (P), volume target, BPM 12, PIP 20 cm H₂O, FIO₂ 21%, PEEP 5 cm H₂O, I:E 1:2.5, PIP High Limit 35 cm H₂O).

Pulse Oximeter

The pulse oximeter and its accessory probes and cables are intended for continuous noninvasive monitoring of functional oxygen saturation of arterial hemoglobin (SpO₂) and pulse rate (measured by the SpO₂ sensor) for infant through adult patients. The pulse oximeter becomes operational in all ventilator modes when its cable and sensor are properly attached to the SpO₂ connector.

To operate the pulse oximeter, connect the sensor probe and the patient cable to the SpO₂ connector on the top of the ventilator. The monitoring function initiates automatically when a valid patient signal is detected for > 10 seconds. The operator can set low and high alarm limits. If an alarm occurs, the operator can use this mitigation to assess the condition of the patient and as an aid in determining what intervention is required.

Humidification

Heat and Moisture Exchangers (HME's) can be used with the unit. While HME's may not be suitable for all applications, they facilitate portability in a way that conventional humidifiers cannot. The unit can be used with an optional HME or an optional HME/bacterial viral filter (HMEF). The HME provides heat and moisture to the inspired gas by recycling the heat and moisture contained in the patient's exhaled gas. Use of an HMEF may help reduce the risk of cross contamination of biological pathogens that might be transmitted in the patient's exhaled gas. HMEs or HMEFs attach between the disposable ventilator circuit and patient's endotracheal tube. Be sure to follow all instructions provided by the manufacturer.

The following table gives guidance on appropriate tidal volume range using various HMEs with Adult, Pediatric, and Infant patients.

Patient	Weight (kg)	V _T Range (ml)	HMEF Dead Space	Circuit Dead Space (ml)	Total Dead Space (ml)	Minimum V _T (ml)
Adult	≥ 40	≥ 400	≤ 75 ml	17 (ped/ adult)	≤ 92	360
Pediatric	12 to 50	120 to 500	≤ 25 ml	17 (ped/ adult)	≤ 42	168
Pediatric	12 to 50	120 to 500	≤ 25 ml	4 (infant/ ped)	≤ 29	117
Infant	5 to 12	50 to 120	≤ 10 ml	4 (infant/ ped)	≤ 14	56

ZOLL does not offer a heated humidifier option for the unit. Users are cautioned to carefully consider the ramifications of such use and the effect it may have upon device performance and the patient's comfort. Such humidifiers have been shown to increase the work of breathing in portable ventilators⁴. Any humidification device should be connected and operated only in accordance with directions provided by its respective manufacturer. Humidifiers are not recommended for transport. Observe all safety and cautionary statements.

Warning! Use of the HME or HME/Bacterial Viral filter (HMEF) may not be indicated in patients with small tidal volumes as the dead space may be greater than 25% of the set Tidal Volume. Always select an HME/HMEF that is appropriate for the patient. For very small tidal volumes (50 to 75 ml), it may be advisable to not use an HME.

Warning! Use of the HME or HME/Bacterial Viral filter (HMEF) will cause a slight increase in the inspiratory effort to trigger an Assisted Breath (approximately 1 cm H₂O).

Warning! Always monitor the patient and ventilator when using restrictive external filters or the external O₂ reservoir. Changing modes with these restrictions can cause false compressor failure alarms under parameter configurations where high air flow is required.

4. Kacmarek et al (Respiratory Care 1990;35:405)

Hazardous Environment Filters

The unit can be used in environments where chemical and/or biological toxins are present. To do this safely, all gas delivered to the patient comes from either a pressurized medical-grade oxygen source and/or filtered ambient air entrained through the Fresh Gas/Emergency Air Intake. Operators can choose between a bacterial/viral filter and a chemical/biological filter based on the direction of the Medical Control Officer.

To prevent the patient from breathing contaminated ambient air in the event of a ventilator failure, the unit contains an internal anti-asphyxia valve that allows the patient to inspire gas through the external filter. While this design assures that no contaminated gas reaches the patient, it requires that the operator ensure that nothing blocks the input of the external filter.

Warning! **The Medical Control Officer and/or Incident Commander should determine which, if any, external filter is used based on the potential hazard.**

Warning! **The operator must ensure that nothing blocks the inlet of the external filter; failure to do so could prevent the patient from breathing and cause an ventilator failure.**

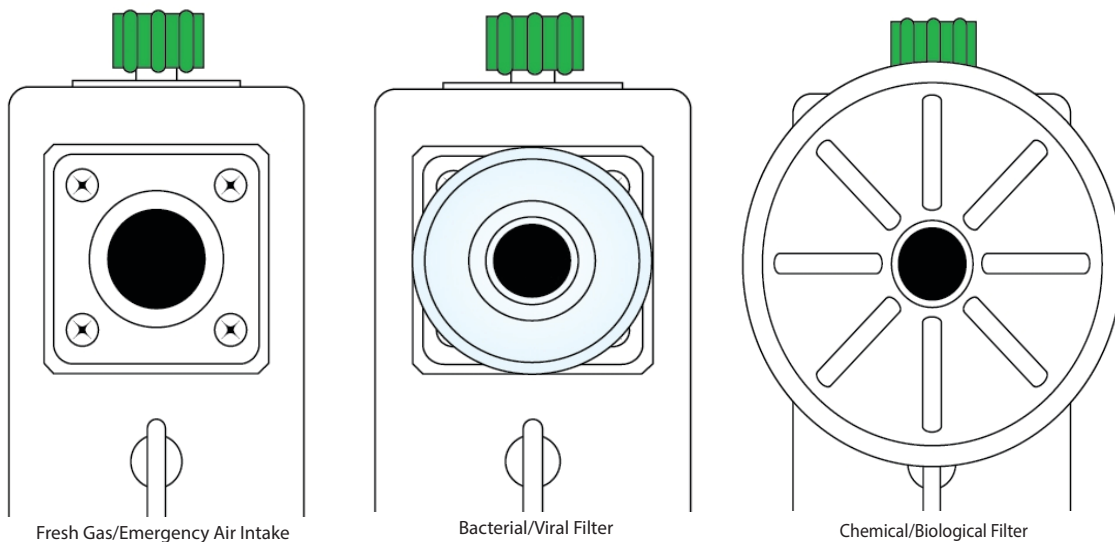

Hazardous Environment Filters

Bacterial/Viral Filter Use

Bacterial/Viral filters (B/V) can be used in environments where the patient is at risk to cross contamination or airborne pathogens. When used in accordance with the manufacturer's instructions, these filters can help prevent inhalation of infectious matter. In dusty environments, the B/V filters can also be used to prevent entrainment of particulate matter that could affect the ventilators pneumatic components. To use a bacterial/viral filter, insert the filter's male 22 mm conical fitting into the Fresh Gas/Emergency Air Intake.

Caution If filters have been exposed to biological matter, dispose of them following the Universal Precaution procedures for your facility.

Chemical/Biological Filter Use

The unit is designed to allow attachment of chemical/biological filter/canister (type C2A1⁵) for use in contaminated environments. The Fresh Gas/Emergency Air Intake fitting allows for attachment of standard Rd 40 x 1/7 threads. A complete description of this standard can be found in BS EN 148-1:1999 Respiratory protective devices - Threads for face pieces.

Check Valve on Breathing Circuit when in Hazardous Environments

When operating in a Hazardous Situation where a chemical/biological filter is in use, the operator should use a Check Valve (Part #704-0700-01) to prevent hazardous gas from entering the patient's breathing circuit. The exhalation valve on the breathing circuit is not adequate to protect patients if they rapidly inhale/exhale as the valve may not fully close in time to prevent hazardous gas entrainment. Also, if the PEEP is set low, patients may inhale faster than the flow is delivered which could cause hazardous gas entrainment. Consequently, a Check Valve is required to protect patients.

Warning! The unit is shipped with both the pediatric/adult and infant/pediatric single limb circuits. A Check Valve (704-0700-01) is required with these breathing circuits when operating in a hazardous environment. The correct mating of the Check Valve with the breathing circuit is shown below. Operators who anticipate use in these environments should also stock the Check Valve.

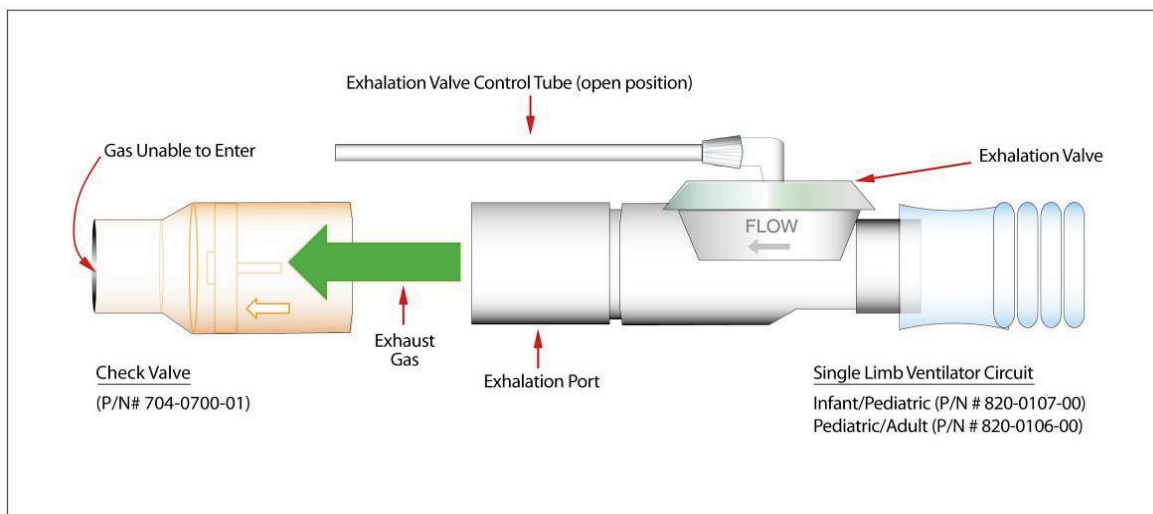

Check Valve Connection To Breathing Circuit

5. A 3M C2A1 canister (3M St. Paul, MN) was used in our validation testing to represent the class of filters generically known as C2A1 under the NSN number 4240-01-361-1319. These tests confirmed the performance of the ventilator when operating with these devices as a class. Use of the 3M canister does not constitute endorsement or recommendation of the 3M device. Use and selection of the appropriate filter should always be under the direction of the Incident Commander.

Harsh Environment Operation

The unit is designed to operate in harsh prehospital environments and during air and ground transport. In order to safely manage the patient, the operator must understand the operating characteristics of the ventilator and diligently monitor the patient and device in these environments. The unit continuously monitors environmental conditions (temperature and ambient pressure) and when extreme environments are detected, the operator is alerted by a Low Priority alarm which defines the operating condition and prompts the actions of the operator. Low Priority alarms are advisory and the operator should remember that the device is operating as designed.

Airborne Particulates

Under normal operating conditions, the internal 2-stage filtration system protects the gas flow path from particulates entrained through the Fresh Gas/Emergency Air Intake. However, when operating in areas where fine dust or dirt is airborne due to wind or vehicle movement, the operator should use a disposable bacterial/viral filter (sometimes called HEPA filter) to preserve the internal filter. Use of these filters will prevent the operator from having to change the internal filters. For extended operation in these environments, the operator should change the filter as it becomes dirty (visually inspect the filter for dust/dirt build up). The primary effect of entrained particles is on the operation of the flow pneumotach used to control the gas delivered to the patient. Dirt on the pneumotach screens affects the calibration. Cleaning the screens requires a biomedical technician to disassemble the device and ultrasonically clean the screens. The best way to prevent taking the unit out of service is to use a filter in dusty environments. In addition to using the filter, the operator can also keep the unit in the soft case, which will protect the unit case and the LCD from becoming scratched or damaged. It is also easier to clean the padded case following use in a dusty/dirty environment than the device.

Extreme Temperature Environments

Traditional transport ventilators typically operate from 0° to 40°C (32° to 104°F). The unit has been validated by ZOLL to be capable of operating over a range of -25° to 49°C (-13° to 120°F) and above when required during emergency situations. (The SGS listed operation range is 10° to 40°C/50° to 104°F.) The primary limit to operating at low or high temperatures is the performance of commercially available Li ion batteries which limit the *charging* temperature to 0° to 45°C (32° to 113°F). However, the batteries have been validated by ZOLL of being capable of *discharging* from -25° to 49°C (-13° to 120°F). In addition, the device has been validated by ZOLL to be capable of operating over the entire range using external power. When the internal battery temperature drops below 0° or goes above 45°C, a Low Priority alarm activates, alerting the operator that the battery is no longer charging. This prevents damage to the Li ion battery from charging at high temperatures, which would void the battery warranty and create a potential hazard. The battery is still capable of discharging and powering the unit. Operators can improve temperature performances by making sure that the unit is in the padded case when operating at low temperatures. The padded case insulates the unit and allows it to retain the heat generated by the compressor, circuit boards, and AC/DC Power Supply. When operating at high temperatures, the operator should remove the unit from the padded case, which allows the unit to pass heat into the surrounding environment.

Altitude

The unit is designed to operate from -2,000 to 25,000 feet (-610 to 7620 meters). An absolute barometric pressure sensor monitors ambient pressure and this information is used to continuously correct the output of the device to maintain the ventilation parameters. When the altitude is > 25,000 feet, the unit activates a Low Priority alarm. When this occurs, the operator should monitor the peak inspiratory pressure (PIP) and adjust the tidal volume to maintain the PIP and monitor breath sounds and chest excursion to assure adequate ventilation is maintained. The tidal volume increases as altitude increases, so the operator should look to prevent over pressurization of the lung when the altitude increases beyond 25,000 feet. If changes are made above 25,000 feet, the operator should revert to the initial settings once operation resumes in the compensated range (the LED will turn from yellow to green).

Warning! **The unit is not intended for hyperbaric operation. Use in a hyperbaric chamber can result in harm to the patient and/or damage to the device.**

Rain and Snow

Like any electronic device, the operator should attempt to prevent exposure to rain or snow. This can be accomplished by using the optional padded case that can be purchased with the unit. The unit is capable of operating in these conditions if the operator keeps the device in the padded case and uses the rain flap, which is provided with the padded case. The padded case and rain flap prevent rain and snow from puddling on any of the device's surfaces. In cases of driving rain, where water could possibly enter the unit's compressor, a bacterial/viral filter can be used to protect the compressor inlet.

Use of Low Flow Oxygen

Introduction

The unit can use oxygen from low flow sources, oxygen flow meters, and oxygen concentrators to provide supplemental oxygen to patients. To do this, oxygen is delivered through the Fresh Gas/Emergency Air Intake when the unit's internal compressor cycles to deliver a breath. In order to assure efficient oxygen delivery, ZOLL recommends that the operator use the Oxygen Reservoir Bag Assembly (Part #704-0004-00). The assembly performs a number of functions.

The Reservoir Bag Assembly

- Acts as a reservoir, collecting oxygen during the expiratory phase of ventilation.
- Provides interference to the ventilator and the attachment of the low-flow oxygen supply hose.
- Provides an inlet in the event the low-flow oxygen supply fails or the tidal volume is greater than the supplied oxygen.

Procedure

1. Press the **MENU** button and use the **ROTARY ENCODER** to select O₂ Reservoir **On**. This tells the unit that the reservoir is attached and prevents the *FRESH GAS INTAKE RESTRICTED* alarm.
2. Attach the oxygen supply hose to the nipple on the reservoir assembly (see figure below).
3. Attach the O₂ Reservoir Bag Assembly to the Fresh Gas/Emergency Air Intake as shown.

Warning! **Always monitor the patient and ventilator when using restrictive external filters or the external O₂ Reservoir. Changing modes with these restrictions can cause false compressor failure alarms under parameter configuration where high flow is required.**

Note: The assembly will function when the reservoir bag is hanging down or lying horizontally, provided the bag does not fall in such a way that closes the neck of the bag.

Note: The ventilator will sound a Low priority *FRESH GAS INTAKE RESTRICTED* alarm if the menu has not been changed (see #1 above). Operating with the alarm active does not affect the ability of the ventilator to deliver breaths at the current settings. It is to alert the operator that a restriction has been detected at the inlet.

4. Adjust the oxygen flow to achieve an acceptable oxygen saturation.

Note: Always allow 5 to 10 minutes between adjustments to assure the patient oxygenation has stabilized. This is very important when delivering the oxygen supply where it may several minutes for a patient to stabilize as the new oxygen flow.

Note: Never use oxygen flows greater than the patient's consumption. Flows greater than this may cause the baseline pressure to drift, waste oxygen, and may cause an *INCOMPLETE EXHALATION* alarm.

Operating Notes

Note: When the reservoir is removed, be sure that the 22 mm adapter is removed with the assembly.

Due to the slight difference between the densities of air and oxygen, the tidal volume will decrease slightly as oxygen is entrained. The worst case is a < 10% decrease in tidal volume when the entrained oxygen results in a FIO₂ of 100%. The following tables show both effect on tidal volume and the resultant FIO₂ for various oxygen supply rates:

	AC 12, V_T 700, PEEP 5, I:E 1:2.5								
O ₂ Flow l/min	0	1	2	3	4	5	6	7	8
FIO ₂	21	30	38	48	57	70	80	89	100
V _T (set)	740	732	725	718	711	703	691	689	682
V _T (actual)	700	692	685	678	671	663	651	649	642
% Chg	0	-1.1	-2.1	-3.1	-4.1	-5.3	-7.0	-7.3	-8.3

	AC 12, V_T 500, PEEP 5, I:E 1:2.5						
O ₂ Flow l/min	0	1	2	3	4	5	6
FIO ₂	21	30	43	56	69	89	100
V _T (set)	527	523	514	506	502	493	486
V _T (actual)	500	496	487	479	479	466	459
% Chg	0	-0.8	-2.6	-4.2	-5.0	-6.8	-8.2

	AC 18, V_T 300, PEEP 5, I:E 1:2.5						
O ₂ Flow l/min	0	1	2	3	4	5	6
FIO ₂	21	32	47	62	76	96	100
V _T (set)	312	307	303	299	298	291	287
V _T (actual)	300	295	291	287	286	279	275
% Chg	0	-1.7	-3.0	-4.3	-4.7	-7.0	-8.3

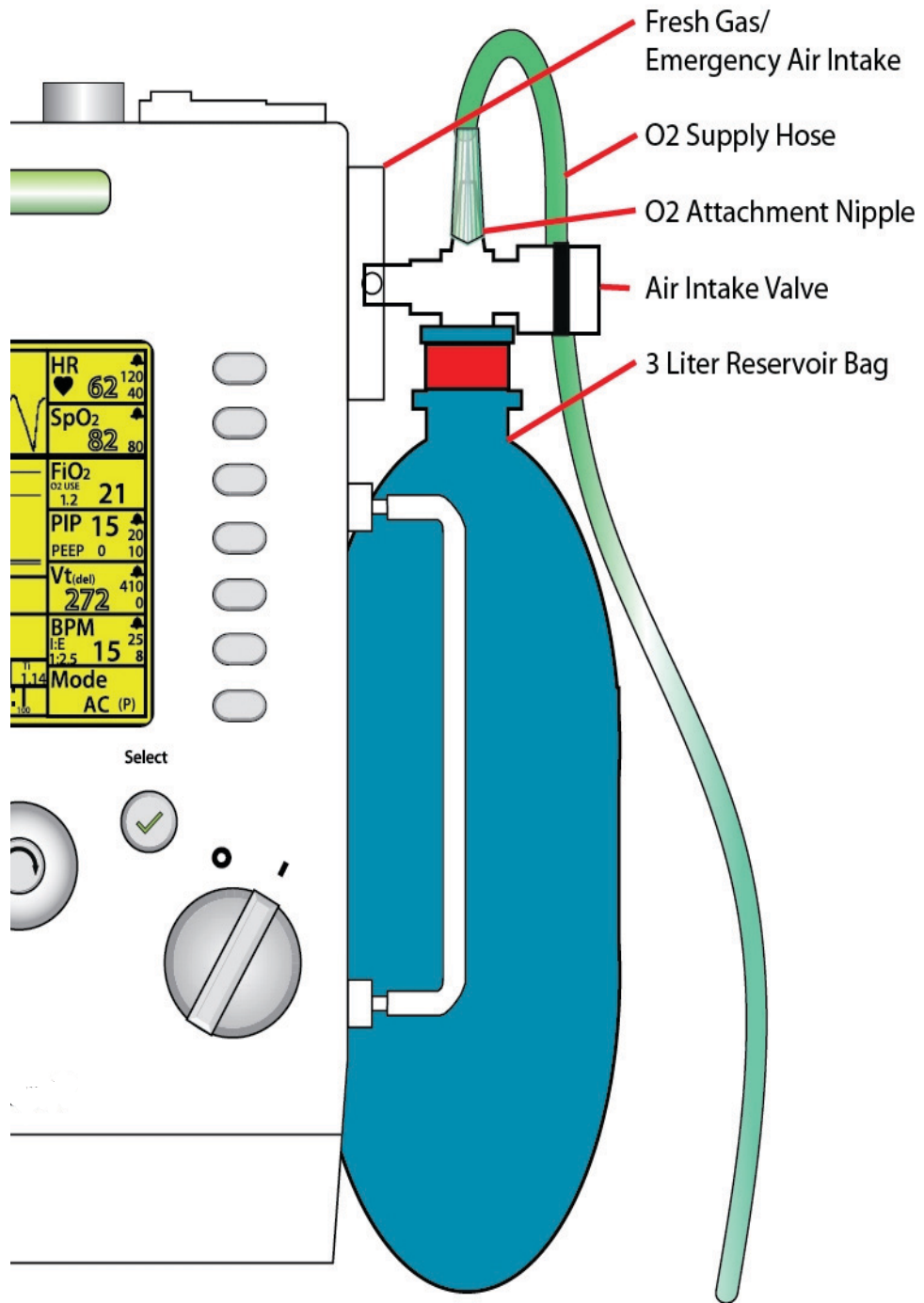

Oxygen Reservoir Bag Assembly

Use In an MRI Environment

MRI Test Details

The unit was evaluated for use in the MRI environment following standard guidance⁶ and test procedures for MRI conditional use (report available upon request). This risk was evaluated by an MRI test performed by Exponent and documented in “MRI Compatibility of Impact EMV+[®] and Eagle II[™] Ventilator-Final Report” by Joseph C. McGowan, PhD PE (8-13-2010). As recommended by the MRI standard guidance, the details of this MRI/ventilator test are being reported in the ZOLL Ventilator Operator’s Guide for use by the operator in comparing the test conditions with their use conditions.

The testing was done with a 3.0 T Siemens Trio scanner, which has a magnetic field of 0.2 T (2000 gauss) at a distance of slightly more than 1 meter (~3.3 feet) from the bore entrance. It was determined that there was no attractive force between the unit/cart at a distance of 1 meter. The ventilator, however, would alarm at this 1 meter distance, due to the influence of the magnetic field that caused the unit to be out of specification. Therefore, the functionality and MRI artifact tests were performed at a distance of 2 meters (~6.6 feet). There was no effect on either the ventilator functionality or the MRI performance at this distance of 2 meters. The scan parameters used for these tests are summarized in the following tables:

Table 1: MRI scan parameters for functionality testing of the ZOLL ventilators

Parameter	3.0 T	
	Turbo Spin-Echo (T2_TSE_TRA_MBH_HYPER)	Volume Interpolated Gradient-Echo (VIBE)
Repetition Time, TR	4,000 ms	4.87 ms
Echo Time, TE	104 ms	2.36 ms
Number of Acquisitions (NEX)	1	1
Matrix	256 x 115	256 x 154
Field of View	35 x 26 cm	35 x 26 cm
Bandwidth	85.8 kHz	76.8 kHz
Slice Thickness	6 mm	4 mm
Flip Angle	120°	10°

6. www.fda.gov “A Primer on Medical Device Interactions with Magnetic Resonance Imaging Systems”, 2/7/1997, R.A. Phillips & M. Skopec; www.ecri.org “Use of equipment in the magnetic resonance (MR) environment” Health Devices, April 2005; www.acr.org “ACR Guidance Document for safe MR Practices: 2007” AJR:188 June 2007, E. Kanal et al.; <http://www.MRIsafety.com> Dr. F.G. Shellock; <http://www.patientsafety.gov/alerts/MRI.doc> “MRI Hazard Summary” August 2001, J. Gosbee and J. DeRosier, VA National Center for Patient Safety.

Table 2: MRI scan parameters for image artifact testing of the ZOLL ventilator and ZOLL roll stand, and functionality of the ventilators.

Parameter	3.0 T	
	Spin-Echo	Gradient-Echo
Sequence Type	Spin-Echo	Gradient-Echo
Repetition Time, TR	500 ms	250 ms
Echo Time, TE	20 ms	15 ms
Number of Acquisitions (NEX)	1	1
Matrix	256 x 256	256 x 256
Field of View	30 x 30 cm	30 x 30 cm
Bandwidth	32.0 kHz	30.7 kHz
Slice Thickness	3 mm	3 mm
Flip Angle	90°	20°

MRI Test Configuration: ZOLL Ventilator and Roll Stand

The EMV+® and Eagle II™ ventilators were subjected to MRI testing while securely mounted in the ZOLL MRI roll stand (Part #816-0731-01) with the aluminum IV support arm (Part #820-0124-00). (The secure mounting is achieved by tightening the knob on the back plate to hold the ventilator in position.) This configuration is illustrated in the figure below:

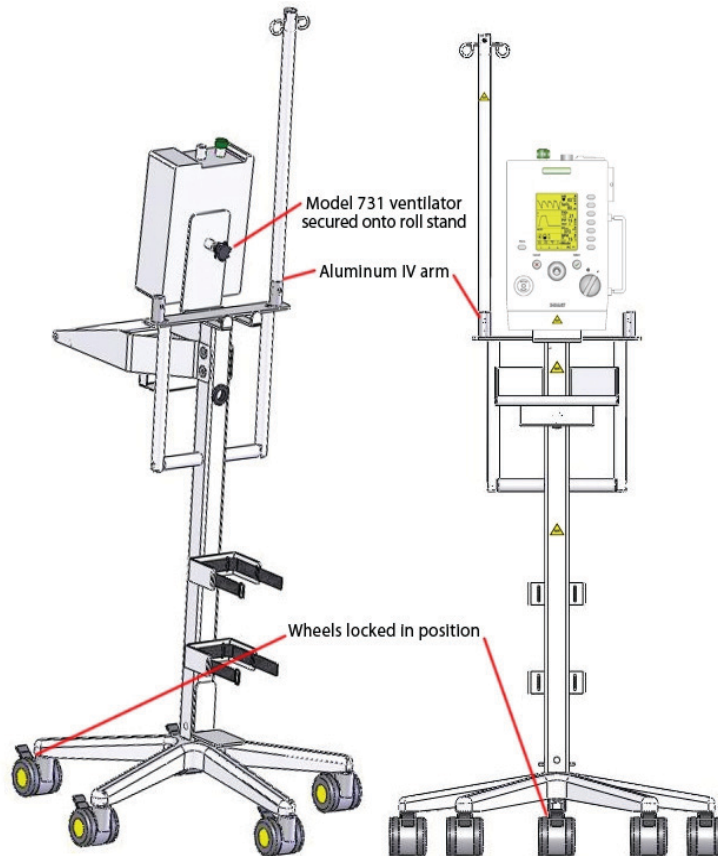

ZOLL Ventilator Mounted On MRI Rolling Stand With IV Support Arm

MRI/Ventilator Hazard Assessment

Warning! Only ZOLL ventilators marked with an “MRI conditional” label should be used in the MRI environment.



MR Labels on ZOLL Ventilator

The four main MRI hazard concerns regarding the use of the ZOLL ventilator in an MRI environment and their remediation are as follows:

Hazard	Hazard Remediation
The static field effects interfere with the operation of the ventilator.	Operator warned to use a distance of 2 meters or more. (Test demonstrates this is not a problem for operation at 2 meters.)
The ventilator could interfere with the MRI imaging and introduce image artifacts.	Operator warned to use a distance of 2 meters or more. (Test demonstrates this is not a problem for operation at 2 meters.)
The ventilator, ventilator accessories, and/or cart could feel magnetic attraction and become a projectile missile hazard to both operator and the patient.	Operator warned to use proper anchoring and not to stand between bore opening and unit/cart. (Test demonstrates this is not a problem for operation at 1 meter.)
The pulse oximeter can heat up in the MRI environment due to induced current from the magnetic field and result in possible burning of the patient and/or the operator.	Operator warned not to use the pulse oximeter.

MRI/Ventilator Warnings

To address the above potential hazards, the following Warnings apply when using the ZOLL ventilator unit in an MRI environment:



- Only ZOLL ventilators marked with an “MRI conditional” label should be used in the MRI environment.
- The operator shall follow all safety procedures that are in effect for the MRI environment.
- Failure to follow these ventilator/MRI instructions can result in the malfunction of the ventilator, MRI artifacts, and/or possible injury to patient/operator.
- The ventilator was successfully tested in a 3.0 T environment when placed behind the 2,000 gauss field line. ZOLL recommends placing the ventilator at least 2m or 6.6’ from the magnet’s bore opening.
- The unit should not be used in an MRI environment which has > 3T magnetic strength.
- The unit’s power transformer shall *not* be brought into the MRI environment. The unit shall operate on battery power only. The battery should be fully charged before bringing into the MRI environment.
- The unit’s pulse oximeter cables shall *not* be brought into the MRI environment.
- The unit shall be secured to a ZOLL MRI roll stand (Part #816-0731-01) or properly secured to another suitable MRI compatible cart prior to entering the MRI environment. Failure to do so could result in the unit becoming a missile projectile.
- The ZOLL MRI roll stand shall be used with the IV arm (aluminum) only (Part #704-0731-09). It shall not be used with the breathing circuit arm (ferrous). The cart shall not have any other ferrous materials placed on it due to projectile missile danger.
- The operator shall use only aluminum, non-magnetic oxygen cylinders, and oxygen regulators.
- The operator shall not use an active humidifier or humidifier holder/bracket in the MRI environment. These could become projectile missiles.
- At no time shall any person be permitted to be between the bore entrance and an unsecured unit/roll stand, due to possible missile projectile danger.
- When the roll stand is in place, the wheels shall be locked. If possible, it is recommended that the stand be tethered in position.
- The unit/roll stand shall be in place and secured in position before the patient is placed on the scanner table and advanced into the bore. It is recommended that the unit/roll stand be tested in the MRI environment prior to its use in patient support. If this is not possible, extra care must be exercised and the unit shall be removed if there is any sign of attractive force with its potential projectile missile danger.
- The patient shall be removed from the MRI environment before the unit/roll stand is removed from the MRI environment.
- The unit’s screen shall be visually monitored for alarms at all times if there is a risk that audible alarms will not be heard, for example during image acquisition.
- The operator shall use only ZOLL MRI breathing circuits (pediatric/adult Part #820-0130-00, infant/pediatric Part #820-0131-00) or other MRI safe breathing circuits that will permit suitable separation between the unit and the bore opening of the magnet.
- Extended length of tubing can result in loss of volume due to additional compressibility. Insure that the patient is receiving correct tidal volume when this circuit is used.
- Do not use this circuit with PEEP settings below 5 cm H₂O.
- Given the additional length of the circuit, the system may not be able to trap PEEP with patients with short expiratory times. Always assure the device is performing as required before beginning MRI study.

OPERATION

The longer breathing circuits may affect the required settings of the vent from the settings used with the shorter breathing circuits in a non-MRI environments.

Caution The use of longer breathing circuits may increase the risk of self-triggering of ventilator breaths. Reducing the pressure trigger sensitivity may solve this problem.

Chapter 4

Alarms

The ZOLL Portable Critical Care Ventilator uses Smart Help™ messages that provide a comprehensive suite of alarms to alert operators and guide their actions to resolve alarm conditions and assure patient safety. At the onset of an alarm, the screen displays the alarm name and then a series of context-sensitive Smart Help messages. These Smart Help messages serve to guide the operator by presenting suggestions as to the cause and resolution of a particular alarm. When multiple alarms occur they are prioritized and displayed based on the risk to the patient.

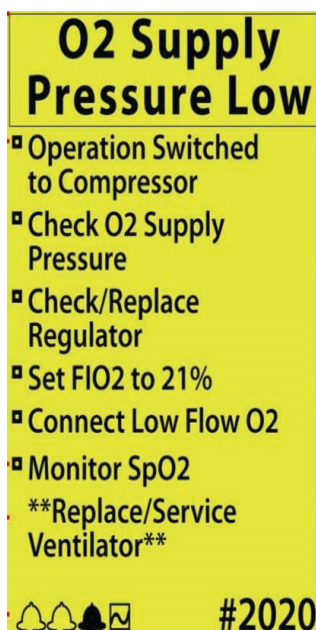

Smart Help Example

Above is an illustration of what is seen if there are several alarms. The Alarm message refers to the alarm bell that is dark. The Operator can cycle through the various alarms by turning the **ROTARY ENCODER**. If there are less than 5 alarms, this alarm list will also include a “plot” icon, where the alarm screen will be replaced by the Pulse Pleth/Time and Pressure/Time plots.

If the alarms are Low Priority, then muting these Low Priority alarms will cause the Pleth and Pressure/Time plots to appear permanently on the screen. If the alarms are Medium Priority, the unit will cycle through each Medium Priority Alarm for a 20 second period. The **ROTARY ENCODER** can be used to select a particular Medium Priority Alarm and/or Plot for 20 seconds, after which the above cycling rotation will resume. New Alarms will overwrite the screen at any time.

Smart Help Messages

At the onset of an alarm, the Alarm Message Center (AMC) in the upper left-hand corner of the LCD screen displays a Smart Help message. The Smart Help message displays the alarm name with a series of messages to help the operator resolve the alarm. The number of active alarms is indicated at the bottom of the AMC as a series of Alarm Bell icons with each bell indicating an active alarm. Alarms are prioritized based on the risk to the patient. The alarm with the greatest risk to the patient is always presented first. All messages are context-based and suggest what is causing the condition and/or how it can be resolved.

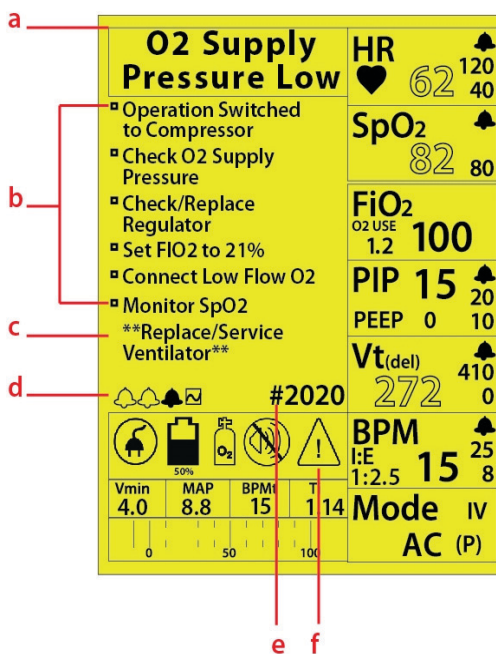

Smart Help Display

Smart Help Messages are presented using the following format, based on the image above:

- **Alarm Message Center (AMC):** Smart Help messages contain the information and instructions for all active alarms, such as:
 - a. **Alarm Name/Description:** Describes the nature and/or cause of the fault or failure. The Alarm Name/Description appears at the top of the AMC. When more than one alarm occurs at the same time, the unit prioritizes them based on patient safety.
 - b. **Mitigation/Resolution Instructions:** Instructions for the operator as to how the alarm state may be resolved.
 - c. **If not Resolved Instructions area:** Instructions for the operator on what to do if they cannot resolve the alarm state. The instruction is always shown in the following format ****Message...****.
 - d. **Alarm Number Icon:** For each active alarm, an alarm bell appears. When multiple alarms are active, the number of bells corresponds to the number of alarms. The alarm in the AMC is demonstrated as the solid bell. To view each active alarm, turn the **ROTARY ENCODER** to scroll through all active alarms. If there are less than 5 alarms, the plot icon will also appear.
 - e. **Service Code:** Each alarm has a 4 digit number associated with it, which helps the operator communicate with technical assistance or biomedical technician support.
 - 1###: High Priority alarms
 - 2###: Medium Priority alarms
 - 3###: Low Priority alarms
 - f. **Attention Warning Icon:** Identifies the severity of the alarm: Low, Medium, or High priority.

Alarm Priorities

Alarm priorities define the operational state of the device regarding its ability to provide mechanical ventilation. The alarm priority determines what effect pressing the **MUTE/CANCEL** button will have. There are three priorities:

- **High Priority:** Mechanical ventilation under operator control is no longer possible. This alarm category requires immediate intervention by the operator. This includes system failure alarms where the CPU has failed and a backup has taken over to sound the audible and visual alarms. It also includes when the device is turned on and there is no internal or external power source. Pressing the **MUTE/CANCEL** button has no effect on the High Priority alarm. The alarm can only be silenced by turning off the ventilator.
- **Medium Priority:** Mechanical ventilation is active or is possible (maybe for a finite period of time), but there is a failure/fault with the patient, ventilator circuit, a pneumatic subsystem, or pulse oximeter. This alarm category requires immediate intervention by the operator. Pressing the **MUTE/CANCEL** button mutes Medium Priority alarms for 30 seconds. If after 30 seconds the alarm-causing condition still exists, the audible alarm will recur until it is muted again for another 30 second period or resolves.
- **Low Priority (Advisory):** Safe mechanical ventilation is active, but there is a fault that the operator must be aware of to ensure safe management of the patient and/or ventilator. Low Priority alarms present with both an audible and yellow LED alarm signal alerting the operator to the condition. Pressing the **MUTE/CANCEL** button cancels the audible signal. If the alarm is not resolved, the yellow LED remains illuminated to remind the operator of the fault or failure. Some Low Priority alarms may be canceled to avoid nuisance alarms.

Ventilator Alarm Categories

Alarms are presented and grouped as categories rather than individual alarms because any given fault/failure may have a different effect on patient safety based on what operating resources are available, environmental conditions, and the severity of the fault/failure. In each case, the unit analyzes the fault/failure and attempts to continue ventilating the patient while guiding the operator to make an appropriate intervention to resolve the condition.

- **CPU Failure:** An unrecoverable failure of the central processor unit (CPU) that controls the user interface and SpO₂ monitoring. When this High Priority alarm occurs, the user interface goes blank and the audible and red LED indicators are active. The backup ventilation system automatically continues to provide ventilation based on the last good settings. The alarm can only be silenced by turning the ventilator off.
- **Compressor Fault/Failure:** Faults or failures with the internal compressor which is used to deliver electrically powered breaths. High Priority alarms occur when the compressor is no longer able to deliver breaths based on the ventilator parameters and there is no 55 psig oxygen supply to operate the O₂ Valve as a backup. When a compressor failure occurs with 55 psig oxygen available, the unit automatically begins ventilation using the O₂ Valve and sounds a Medium Priority alarm. To clear the alarm, the operator is required to manually set the FIO₂ to 100%; the Medium Priority alarm changes to a Low Priority alarm, with a yellow LED and persistent message. Low Priority alarms associated with the compressor system involve restrictions through the pneumotach screen or internal gas path that are detected by an internal sensor. Although outside the normal operating conditions, the unit is still able to deliver breaths within the ventilator parameters.

Note: Failures of the compressor will prevent the entrainment of low flow oxygen through the Fresh Gas/Emergency Air Intake.

- **O₂ Valve Fault/Failure:** Faults or failures of the O₂ Valve which is used to control pneumatically/oxygen powered breaths. High Priority alarms occur when there is a failure of the O₂ Valve and the internal compressor is not available for backup due to a secondary failure. When the O₂ Valve fails and the FIO₂ is > 21%, the unit automatically begins ventilation using the compressor and sounds a Medium Priority alarm. To clear the alarm, the operator is required to manually set the FIO₂ to 21%; the Medium Priority alarm changes to a Low Priority alarm, with a yellow LED and persistent message. Low Priority alarms associated with the O₂ Valve involve restrictions through the pneumotach or internal gas path that are detected by internal sensors. Although outside the normal operating conditions, the unit is still able to deliver breaths within the ventilator parameters.
- **Oxygen Supply Pressure Low Fault/Failure:** Faults or failures of the 55 psig oxygen supply and/or the unit's ability to detect the presence of high-pressure oxygen. High Priority alarms occur when the oxygen supply pressure drops below 35 psig and the internal compressor is not available for backup due to a secondary failure. When the oxygen supply pressure drops below 35 psig and the FIO₂ is > 21%, the unit automatically begins ventilation using the compressor and sounds a Medium Priority alarm. To clear the alarm, the oxygen supply pressure must be > 45 psig or the operator must manually set the FIO₂ to 21%; the Medium Priority alarm is then canceled.

Note: The operator should recognize that setting the FIO₂ to 21% is acknowledging that the patient is being ventilated without supplemental oxygen. There are no Low Priority alarms associated with this fault/failure.

- **Oxygen Supply Pressure High Fault/Failure:** Faults or failures of the 55 psig oxygen supply and/or the unit's ability to detect the presence of high-pressure oxygen. High Priority alarm occurs when the oxygen supply pressure is ≥ 80 psig. When the oxygen supply pressure is >80 psig, the unit automatically shuts down to prevent harm to the patient and/or damage to the unit. When the pressure is ≥ 75 and ≤ 80 psig, a Low Priority alarm sounds, warning the operator of the potential shutdown should pressure increase beyond the current level.

-
- **Fresh Gas Intake Fault/Failure:** Obstructions of the Fresh Gas/Emergency Air Intake. These obstructions can be the result of mechanical blockage of the intake (such as a plastic bag) or by using an inappropriate filter, when the internal or external filters become dirty or clogged, or when the low pressure oxygen reservoir is used. The pressure drop across the intake is continuously monitored. A High Priority alarm occurs when the obstruction prevents the compressor from delivering a breath that meets the ventilator settings and there is no 55 psig oxygen supply to operate the O₂ Valve as a backup. A Medium Priority alarm occurs when the obstruction prevents the compressor from delivering a breath that meets the ventilator settings and there is a 55 psig oxygen supply to operate the O₂ Valve as a backup. Changing FIO₂ to 100% will downgrade this alarm to Low Priority. A Low Priority alarm will occur when the intake is restricted, but the compressor can still deliver a breath that meets the ventilator settings.
 - **Power Fault/Failure:** Power management and the supply of power from external sources and the internal rechargeable battery. High Priority alarms alert the operator to power failures where there is no backup power alternative or failures of the internal power management system. The alarm can only be silenced by turning the ventilator off. Low Priority alarms are associated with faults or failures that occur where a backup power source is available either by using the internal battery or through use of the external power source. Pressing the **MUTE/CANCEL** button cancels the audible alarm while a persistent message remains.

Note: The unit has the ability to automatically disconnect itself from external power sources that are providing power outside of the safe power range. When the unit detects that the external power supply is within range, it automatically reconnects to the external source to power operation and recharging of the internal battery.
 - **Low Battery Power:** Power remaining in the internal battery and its ability to continue ventilator operation. High Priority alarms signal that the battery no longer has the power to continue ventilator operation and there is no external source detected. The alarm can only be silenced by turning the ventilator off. Medium Priority alarms alert the operator that the unit has approximately 5 minutes of operating time remaining. Pressing the **MUTE/CANCEL** button mutes the audible alarm for 30 seconds. The Low Priority alarm occurs during internal battery operation when the unit determines that there is approximately 30 minutes of operating time remaining. Pressing the **MUTE/CANCEL** button cancels the audible alarm, but the persistent message and yellow LED remain.
 - **Missing Battery:** Operating the unit without an internal battery or operation when the ventilator is not able to detect the internal battery. The Low Priority alarm alerts the operator that the device is operating on external power and that the unit does not have the ability to automatically switch to internal battery power in the event of an external power failure. Pressing the **MUTE/CANCEL** button cancels the audible alarm, but the persistent message and yellow LED remain.
 - **SPM Change:** Occurs when the CPU does not recognize the smart pneumatic module (SPM). The failure is most often associated with a mix up during servicing where the complete unit was not properly calibrated after a new SPM was installed. The alarm can only be silenced by turning the ventilator off and sending it in for service.
 - **Calibration Fault/Failure:** Internal sensors that monitor and control breath delivery. High Priority alarms occur when there is a failure in one or more of the sensors that prevent the unit from safely delivering breaths. Medium Priority faults occur when the sensors are not able to establish an airway pressure baseline. While the unit attempts to recalibrate the sensor, the audible and visible alarms sound. Pressing the **MUTE/CANCEL** button mutes the alarm for 30 seconds.
 - **Exhalation System Fault/Failure:** The control of the exhalation valve and airway pressure. High Priority alarms occur when the airway pressure exceeds the Pressure Limit value or 40 cm H₂O for more than 5 seconds, or when the airway pressure is > 75 cm H₂O for more than 1.5 seconds. Medium Priority alarms occur when the end expiratory pressure does not reach the baseline pressure before the start of the next breath. Resolution of this fault is typically associated with problems causing restrictions to the exhalation valve. Pressing the **MUTE/CANCEL** button mutes the audible alarm for 30 seconds.

- **Airway Pressure High:** Triggered when the airway pressure exceeds the High Airway Pressure Limit value for two consecutive breaths. Patient related causes for this Medium Priority alarm are patient coughing, ventilator dissynchrony, or excess secretions in the airway. Other causes include kinks in the ventilator circuit tubing or a High Airway Pressure value that is too low given the airway pressure. The default value at start up is 35 cm H₂O. Pressing the **MUTE/CANCEL** button mutes the audible alarm for 30 seconds.
- **PEEP Not Met/Leak:** Triggered when the ventilator detects a drift of more than 2 cm H₂O in the end expiratory pressure. This Medium Priority alarm is most often associated with a loose or disconnected circuit hose or tube. The alarm can also be triggered when leaks are present during noninvasive mask ventilation or when uncuffed endotracheal or tracheostomy tubes are used. The operator should also check to make sure the exhalation valve is firmly attached to the circuit and that the cap is securely attached to the body of the assembly. Pressing the **MUTE/CANCEL** button mutes the audible alarm for 30 seconds.
- **Disconnect:** Triggered when the peak airway pressure fails to go 5 cm H₂O above the baseline pressure before the end of the inspiratory phase. This Medium Priority alarm is associated with disconnects between the patient port of the circuit and the patient airway. It can also be caused by a loose or disconnected circuit hose or tube. Pressing the **MUTE/CANCEL** button mutes the audible alarm for 30 seconds.
- **RTC Battery Fault/Failure:** The voltage of the real-time clock (RTC) battery that powers the memory that stores calibration and service information. The operator should take the ventilator out of service when appropriate. A Low Priority alarm is sounded when RTC battery voltage drops below the replacement threshold. Pressing the **MUTE/CANCEL** button mutes the audible alarm, but the persistent message and yellow LED remain.
- **Calibration Due:** This Low Priority alarm is triggered when the time since its last calibration has passed its next due date. Pressing the **MUTE/CANCEL** button mutes the audible alarm, but the persistent message and yellow LED remain.
- **Ambient Pressure Fault:** Triggered when the ventilator senses that it is operating outside of its designed ambient pressure range (-2,000 to 25,000 feet altitude). This Low Priority alarm alerts the operator that there may be some effect on the delivered volume and to monitor the airway pressure and breath sounds to assure adequate ventilation of the patient. Pressing the **MUTE/CANCEL** button mutes the audible alarm, but the persistent message and yellow LED remain.
- **Ambient Temperature Fault:** Triggered when the ventilator senses that it is operating outside of its designed temperature range (-25 to 50°C). This Low Priority alarm alerts the operator that there may be some effect on the delivered volume and to monitor the airway pressure and breath sounds to assure adequate ventilation of the patient. Pressing the **MUTE/CANCEL** button mutes the audible alarm, but the persistent message and yellow LED remain.

Pulse Oximeter Alarms

- **Low SpO₂:** Triggered when the SpO₂ value drops below the Low SpO₂ alarm limit. The Medium Priority alarm alerts the operator to a decrease in the patient's oxygenation status. Resolution of the alarm may involve increasing the FIO₂ or suctioning the patient. Pressing the **MUTE/CANCEL** button mutes the audible alarm for 30 seconds. The default low alarm limit at start up is 94%.
- **High Heart Rate:** Triggered when the heart rate (HR) monitored by the pulse oximeter is above the High HR alarm limit. The Medium Priority alarm alerts the operator to bradycardia. Pressing the **MUTE/CANCEL** button mutes the audible alarm for 30 seconds. The default high alarm limit at start up is 120 beats/minute.
- **Low Heart Rate:** Triggered when the heart rate (HR) monitored by the pulse oximeter is below the Low HR alarm limit. The Medium Priority alarm alerts the operator to bradycardia. Pressing the **MUTE/CANCEL** button mutes the audible alarm for 30 seconds. The default high alarm limit at start up is 40 beats/minute.
- **SpO₂ Shutdown:** Failure of the pulse oximeter. This Medium Priority alarm alerts the operator to a failure of the pulse oximeter that is nonrecoverable or that communication between the CPU and pulse oximeter has failed. Pressing the **MUTE/CANCEL** button mutes the audible alarm for 30 seconds. In order to suspend the alarm, the operator is required to use the Menu controls to place SpO₂ monitoring in standby (*stby*). Doing this cancels the Medium Priority alarm, but the persistent message and yellow LED remain.
- **No SpO₂ Sensor Connected:** Triggered during SpO₂ monitoring when the pulse oximeter does not detect the presence of a functioning SpO₂ sensor. This alarm will not occur when the pulse oximeter is in standby (*stby*). The Low Priority alarm most often occurs when the SpO₂ sensor cable becomes disconnected from the ventilator. To clear the alarm, reattach the sensor cable to the ventilator. The alarm can also be suspended, by pressing the **MUTE/CANCEL** button, pressing the Menu button, selecting Pulse Oximeter, and setting the field to standby (*stby*).

Note: If the unit is started without a pulse oximeter sensor cable attached, pulse oximeter monitoring does not start and the alarms are not enabled. At any time after start up, attaching the sensor to the ventilator and patient automatically starts monitoring and all alarms are enabled.

- **Defective SpO₂ Sensor:** Triggered when the pulse oximeter detects a bad sensor. The Low Priority alarm prompts the operator to check and/or replace the sensor as needed. Pressing the **MUTE/CANCEL** alarm cancels the alarm. To clear the alarm, check/replace the sensor or suspend SpO₂ monitoring by placing it in standby (*stby*).
- **Low SpO₂ Perfusion:** Triggered when the pulse waveform is marginal. The Low Priority alarm alerts the operator to check the sensor site and reposition as needed. Pressing the **MUTE/CANCEL** button cancels the alarm. To clear the alarm, check/replace the sensor or suspend SpO₂ monitoring by placing it in standby (*stby*).
- **Poor SpO₂ Signal:** Triggered when the pulse waveform is marginal. The Low Priority alarm alerts the operator to check the sensor site and reposition as needed. Pressing the **MUTE/CANCEL** button cancels the alarm. To clear the alarm, check/replace the sensor or suspend SpO₂ monitoring by placing it in standby (*stby*).
- **SpO₂ Pulse Search:** Triggered whenever the pulse oximeter is not able to detect a pulse waveform. The Low Priority alarm alerts the operator to check the position of the sensor, patient movement, and/or the perfusion at the sensor site. Pressing the **MUTE/CANCEL** button cancels the alarm. To clear the alarm, reposition the sensor to a better site or suspend SpO₂ monitoring by placing it in standby (*stby*).
- **SpO₂ Interference Detected:** Triggered when the sensor and/or cable are exposed to significant electromagnetic interference. This Low Priority alarm can be caused by powerful radio or radar equipment. Pressing the **MUTE/CANCEL** button cancels the alarm. To clear the alarm, reposition the sensor to a better site or suspend SpO₂ monitoring by placing it in standby (*stby*).

- **SpO₂ Sensor Off Patient:** Triggered when the pulse oximeter detects that it is no longer connected to the patient. The Medium Priority alarm alerts the operator to check the position of the sensor, patient movement, and/or the perfusion at the sensor site. Pressing the **MUTE/CANCEL** button cancels the alarm. To clear the alarm, reposition the sensor to a better site or suspend SpO₂ monitoring by placing it in standby (*stby*).
- **SpO₂ Light Contamination:** Triggered when the SpO₂ signal is corrupted by an external light signal. The Low Priority alarm alerts the operator that too much external light (sunlight, surgical light, etc) is affecting the sensor. Pressing the **MUTE/CANCEL** button cancels the alarm. To clear the alarm, shield the sensor from direct light using a cloth or paper towel.
- **Unrecognized SpO₂ Sensor:** Triggered when the pulse oximeter detects connection with an inappropriate sensor to the ventilator. The Low Priority alarm alerts the operator that the attached probe is not designed to work with the pulse oximeter in the ventilator. Pressing the **MUTE/CANCEL** button cancels the alarm. To clear the alarm, use an appropriate sensor or suspend SpO₂ monitoring by placing it in standby (*stby*).

List of Alarms

The following table lists all of the alarms, along with a brief description, their respective service code, and mitigation/resolution information:

Service Code	Alarm Name/Mitigation/Resolution
1001	<p>Compressor Failure (Compressor Control Fault - No Backup) The compressor fails to operate or fails to provide the flow required to deliver a breath and high-pressure oxygen (HP O₂) is not available to provide ventilation. <i>Mitigation/Info: Manually Ventilate Patient, Connect HP O₂, Restart Ventilator With HP O₂</i> **Replace/Service Ventilator**</p>
1002	<p>Compressor Failure (Compressor Signal Chain Fault - No Backup) Communication between the compressor controller and Smart Pneumatic Module (SPM) is lost and high-pressure oxygen (HP O₂) is not available to provide ventilation. <i>Mitigation/Info: Manually Ventilate Patient, Connect HP O₂, Restart Ventilator With HP O₂</i> **Replace/Service Ventilator**</p>
1003	<p>Self Check Failure The flow from the first breath is $\pm 20\%$ of the expected flow for the tidal volume at start up. This unusually low RPM is a symptom of a dirty flow screen which cannot be serviced by the operator. <i>Mitigation/Info: Manually Ventilate Patient</i> **Replace/Service Ventilator**</p>
1010	<p>O₂ Valve Failure (O₂ Valve Failed Open) The O₂ Valve fails in the open position which results in continuous inspiratory flow. When this occurs, the unit automatically opens the exhalation valve to prevent pressure from accumulating in the circuit and ventilation stops. <i>Mitigation/Info: Manually Ventilate Patient</i> **Replace/Service Ventilator**</p>
1011	<p>O₂ Valve Failure (O₂ Valve Control Fault - No Back Up) The signal to the O₂ Valve is not delivering the required flow rate and the compressor is not available to provide ventilation. <i>Mitigation/Info: Manually Ventilate Patient</i> **Replace/Service Ventilator**</p>

Service Code	Alarm Name/Mitigation/Resolution
1012	<p>O2 Valve Failure (O2 Valve Signal Chain Fault - No Back Up) The communication between the O₂ Valve and the SPM fails and the compressor is not available to provide ventilation. <i>Mitigation/Info: Manually Ventilate Patient</i> **Replace/Service Ventilator**</p>
1020	<p>O2 Supply Pressure Low The oxygen supply pressure is ≤ 35 psig and the compressor is not available to support ventilation. If the oxygen source can be restored, the unit should be cycled off then on to reset. By design, the unit will not reestablish oxygen operation unless the supply pressure is ≥ 40 psig. If the supply pressure is between 40 and 80 psig, the operator should check all hose connections for leaks. Occasionally, this alarm can be caused by a regulator that provides a static pressure within range but is not able to provide the flow necessary to meet the patient flow demand. <i>Mitigation/Info: Manually Ventilate Patient, Connect 55 psig O2 then Restart, Check O2 Supply for Leaks, Replace Regulator</i> **Replace/Service Ventilator**</p>
1030	<p>Fresh Gas Intake Failure (Compressor Intake Blocked - No Backup) The Fresh Gas/Emergency Air Intake is blocked so that the compressor is not able to deliver flow sufficient for the current settings and HP O₂ is not available to support ventilation. The operator should clear the blockage and restart the compressor. (A false alarm can be triggered in very high vibration environments.) <i>Mitigation/Info: Manually Ventilate Patient, Clear Blocked Intake, Connect 55 psig O2, Restart Ventilator</i> **Replace/Service Ventilator**</p>
1041	<p>O2 Supply Pressure High The oxygen supply is > 80 psig. Pressures above 80 psig could result in a catastrophic failure, harm to the patient and/or damage to the unit. While the patient is manually ventilated, the operator or assistant should seek to reduce the oxygen supply pressure. Sometimes, this requires changing the regulator which is not functioning as required. If the pressure cannot be reduced and a low flow device like a flow meter is available, the operator can provide supplemental oxygen via the optional low flow oxygen reservoir. To clear the alarm, the unit should be turned off and then restarted with supply pressure in the appropriate range (40 to 80 psig) or without HP O₂ connected. <i>Mitigation/Info: Manually Ventilate Patient, Decrease O2 Supply to 55 psig, Replace Regulator, Connect Low Flow O2</i> **Restart Ventilator without O2 Supply**</p>
1051	<p>Run-Time Calibration Failure There is a failure of the calibration system. When this occurs, the patient should be manually ventilated, the unit removed from use and sent for service. (A false alarm can be triggered in very high vibration environments.) <i>Mitigation/Info: Manually Ventilate Patient</i> **Replace/Service Ventilator**</p>
1052	<p>Airway Pressure Sensing Failure Communication between the airway pressure sensor and SPM is lost. When this happens, the operator should manually ventilate the patient, replace the ventilator, and send the unit for service. <i>Mitigation/Info: Manually Ventilate Patient</i> **Replace/Service Ventilator**</p>

Service Code	Alarm Name/Mitigation/Resolution
1060	<p>Exhalation System Failure (Exhalation Valve Failure) The exhalation control valve fails to operate. When this happens, the unit stops ventilating and attempts to discharge the pressure in the breathing circuit to atmosphere. This failure may be caused by a significant blockage of the exhalation valve or an occlusion/kink in the exhalation valve tube. If possible, the operator should replace the breathing circuit and restart the ventilator. If this does not resolve the problem, then send the unit in for service. <i>Mitigation/Info: Manually Ventilate Patient, Replace Circuit and Restart</i> **Replace/Service Ventilator**</p>
1061	<p>Exhalation System Failure (Excessive Airway Pressure) The airway pressure (P_{aw}) is above 40 cm H₂O, the PIP High Limit (when PIP High Limit is < 35 cm H₂O) for > 5 seconds, or when the P_{aw} is above 75 cm H₂O for > 1.5 seconds. When this happens, the unit stops ventilating and attempts to discharge the pressure in the breathing circuit to atmosphere. This failure may be caused by a significant blockage of the exhalation valve or an occlusion/kink in the exhalation valve tube. If possible, the operator should replace the breathing circuit and restart the ventilator. If this does not resolve the problem, then send the unit in for service. <i>Mitigation/Info: Manually Ventilate Patient, Replace Circuit and Restart</i> **Replace/Service Ventilator**</p>
1172	<p>5 Volt Self Check Failure The 5 volt power bus fails to provide the required voltage. If this failure occurs, the operator should manually ventilate the patient, replace the ventilator, and send the unit for service. <i>Mitigation/Info: Manually Ventilate Patient, Ventilator Not Functioning</i> **Replace/Service Ventilator**</p>
1173	<p>Internal Communication Failure (Host Device Communication Failure) Communication fails between one of the subcomponents and the hose processor. If this failure occurs, the operator should manually ventilate the patient, replace the ventilator, and send the unit in for service. <i>Mitigation/Info: Manually Ventilate Patient, Backup Ventilator Enabled</i> **Replace/Service Ventilator**</p>
1174	<p>Off Set Self Check Failure The device is not able to calibrate the one or more transducers and is no longer able to operate safely. If this failure occurs, the operator should manually ventilate the patient, replace the ventilator, and send the unit in for service. <i>Mitigation/Info: Manually Ventilate Patient, Ventilator Not Functioning</i> **Replace/Service Ventilator**</p>
1175	<p>Internal Communication Failure There is a failure of the internal communication bus and the host is not able to communicate with the subassemblies. If this failure occurs, the operator should manually ventilate the patient, replace the ventilator, and send the unit in for service. <i>Mitigation/Info: Manually Ventilate Patient, Ventilator Not Functioning</i> **Replace/Service Ventilator**</p>
1176	<p>Off Set Self Check Failure The calibration file fails its integrity check. If this failure occurs, the operator should manually ventilate the patient, replace the ventilator, and send the unit in for service. <i>Mitigation/Info: Manually Ventilate Patient, Ventilator Not Functioning</i> **Replace/Service Ventilator**</p>
1420	<p>Complete Power Failure Power is lost from both the internal battery and an external source during operation. When this occurs, the LCD blanks (no power for operation); the audible alarm pulses rapidly, and the visual alarm flashes rapidly. This alarm will last for approximately two minutes. <i>Mitigation/Info: No LCD Display</i></p>

Service Code	Alarm Name/Mitigation/Resolution
1430	<p>Empty Battery</p> <p>The internal battery power drops below the amount required to provide ventilation and external power is not connected. When this occurs, there is enough power to operate the user interface and provide information to the operator. The patient should be manually ventilated while an external source of power is sought. To cancel the alarm and begin operation with external power, the unit must be turned off and then back on.</p> <p><i>Mitigation/Info: Manually Ventilate Patient, Connect to External Power, Restart Ventilator</i></p> <p>**Replace/Service Ventilator**</p>
1471	<p>Internal Communication Failure</p> <p>The device is no longer able to communicate with the User Interface Module (UIM) and the interface controls. When this occurs, ventilation continues at the current settings or the backup mode settings and the High Priority alarm sounds. The patient should be manually ventilated and the ventilator sent in for service.</p> <p><i>Mitigation/Info: Manually Ventilate Patient, Backup Ventilator Enabled</i></p> <p>**Replace/Service Ventilator**</p>
1472	<p>Internal Communication Failure</p> <p>The device is no longer able to communicate with the Smart Pneumatic Module (SPM). When this occurs, ventilation continues at the current settings or the backup mode settings and the High Priority alarm sounds. The patient should be manually ventilated and the ventilator sent in for service.</p> <p><i>Mitigation/Info: Manually Ventilate Patient, Backup Ventilator Enabled</i></p> <p>**Replace/Service Ventilator**</p>
1473	<p>Internal Communication Failure</p> <p>No valid data is sent from the SPM within 1 second. When this occurs, ventilation continues at the current settings or the backup mode settings and the High Priority alarm sounds. The patient should be manually ventilated and the ventilator sent in for service.</p> <p><i>Mitigation/Info: Manually Ventilate Patient, Backup Ventilator Enabled</i></p> <p>**Replace/Service Ventilator**</p>
1475	<p>LCD Control Failure</p> <p>The device has lost communication with the contrast control and in most instances the content of the LCD is not visible. When this occurs, ventilation continues at the current settings or the backup mode settings and the High Priority alarm sounds. The patient should be manually ventilated and the ventilator sent in for service.</p> <p><i>Mitigation/Info: Manually Ventilate Patient, Backup Ventilator Enabled</i></p> <p>**Replace/Service Ventilator**</p>
1480	<p>SPM Compatibility Failure</p> <p>The unit and SPM software loads are not compatible. This alarm is typically associated with an SPM change where the technician failed to update the unit and SPM to the current software revision. Ventilation is provided using the backup mode settings. The unit should be removed from use and sent in for service.</p> <p><i>Mitigation/Info: Manually Ventilate Patient, Software Compatibility Failure</i></p> <p>**Replace/Service Ventilator**</p>
1485	<p>Power-On Self Check Failure</p> <p>The Smart Pneumatic Module (SPM) software fails and is shut down. Powering the unit off allows the software to reset and may allow operation to continue.</p> <p><i>Mitigation/Info: Manually Ventilate Patient, Abnormal Reset Detected, Restart Ventilator</i></p> <p>**Replace/Service Ventilator**</p>

ALARMS

Service Code	Alarm Name/Mitigation/Resolution
2001	<p>Compressor Fault</p> <p>The communication between the compressor and the SPM fails and HP O₂ is available to provide ventilation. The alarm will continue to sound as a Medium Priority alarm until the operator acknowledges that ventilation is being provided using HP O₂ by setting the FIO₂ to 100%. At this time, the alarm priority changes to Low. While operating in this state, the operator should assure an adequate supply of HP O₂. Failure to maintain the HP O₂ supply will result in a High Priority alarm.</p> <p><i>Mitigation/Info: Operation Switched to O2 valve, Set FIO₂ to 100%</i></p> <p>**Replace/Service Ventilator**</p>
2002	<p>Compressor Fault</p> <p>The communication between the compressor controller and the SPM is lost and HP O₂ is available to provide ventilation. The alarm will continue to sound as a Medium Priority alarm until the operator acknowledges that ventilation is being provided using HP O₂ by setting the FIO₂ to 100%. At this time, the alarm priority changes to Low. While operating in this state, the operator should assure an adequate supply of HP O₂. Failure to maintain the HP O₂ supply will result in a High Priority alarm.</p> <p><i>Mitigation/Info: Operation Switched to O2 valve, Set FIO₂ to 100%</i></p> <p>**Replace/Service Ventilator**</p>
2011	<p>O₂ Valve Fault</p> <p>The signal to the O₂ Valve is outside of the calibration range for the required flow rate and the compressor is available to provide ventilation. The alarm will continue to sound as a Medium Priority alarm until the operator acknowledges that ventilation is being provided using HP O₂ by setting the FIO₂ to 21%. At this time, the alarm priority changes to Low. While operating in this state, the operator should assure an adequate oxygenation is maintained. If low flow oxygen is available, it can be entrained through the Fresh Gas/Emergency Air Intake using the optional O₂ Reservoir. Maintain an acceptable SpO₂ by adjusting the oxygen supply up or down to increase or decrease the amount of oxygen delivered to the patient.</p> <p><i>Mitigation/Info: Operation Switched to Compressor, Set FIO₂ to 21%, Connect Low Flow O2, Monitor SpO₂</i></p> <p>**Replace/Service Ventilator**</p>
2012	<p>O₂ Valve Fault</p> <p>The communication between the O₂ Valve and the SPM fails and the compressor is available to provide ventilation. The alarm will continue to sound as a Medium Priority alarm until the operator acknowledges that ventilation is being provided using HP O₂ by setting the FIO₂ to 21%. At this time, the alarm priority changes to Low. While operating in this state, the operator should assure an adequate oxygenation is maintained. If low flow oxygen is available, it can be entrained through the Fresh Gas/Emergency Air Intake using the optional O₂ Reservoir. Maintain an acceptable SpO₂ by adjusting the oxygen supply up or down to increase or decrease the amount of oxygen delivered to the patient.</p> <p><i>Mitigation/Info: Operation Switched to Compressor, Set FIO₂ to 21%, Connect Low Flow O2, Monitor SpO₂</i></p> <p>**Replace/Service Ventilator**</p>

Service Code	Alarm Name/Mitigation/Resolution
2020	<p>O2 Valve Fault</p> <p>The oxygen supply pressure is < 35 psig and the compressor is available to provide ventilation. When this occurs, the unit begins ventilation using the compressor. The alarm will continue to sound as a Medium Priority alarm until the operator acknowledges that ventilation is being provided using the compressor by setting the FIO₂ to 21%. The alarm will cancel completely when the operator sets to 21%.</p> <p>Note: The device is designed to work with or without external oxygen. If HP O₂ is connected, the unit will not continue oxygen operation unless the supply pressure is ≥ 40 psig. This is done to prevent continuous cycling between alarms during the inspiratory phase and not alarm during expiratory phases. If low flow oxygen is available, it can be entrained through the Fresh Gas/Emergency Air Intake using the optional O₂ Reservoir. Maintain an acceptable SpO₂ by adjusting the oxygen supply up or down to increase or decrease the amount of oxygen delivered to the patient.</p> <p><i>Mitigation/Info: Operation Switched to Compressor, Check O2 Supply Pressure, Check/Replace Regulator, Set FIO₂ to 21%, Connect Low Flow O2, Monitor SpO₂</i></p> <p>**Replace/Service Ventilator**</p>
2030	<p>Fresh Gas Intake Fault</p> <p>The Fresh Gas/Emergency Air Intake is blocked so that the compressor is not able to deliver a breath within ± 10% of the current settings and HP O₂ is available to support ventilation. When this occurs, the ventilator immediately switches to HP O₂ powered ventilation. To clear the alarm, first set the FIO₂ to 100% to acknowledge that the patient is being ventilated at 100%, clear the blockage, and then set the FIO₂ back to the original value. Once the blockage has been cleared, operation with the compressor will restart. If the blockage cannot be cleared, the alarm will resound, continue ventilation with FIO₂ set at 100%, and assure an adequate supply of HP O₂. A high vibration environment can trigger this alarm. If necessary, the operator can activate the O₂ Reservoir Mode while continuing to operate normally. This will suppress the alarm.</p> <p><i>Mitigation/Info: Operation Switched to O2 Valve, Clear Blocked Intake, Set FIO2 to 100%, Monitor SpO₂</i></p> <p>**Replace/Service Ventilator**</p>
2053	<p>Suspicious Triggers</p> <p>Airway pressure sensor fails to calibrate the expiratory phase of a breath. When this occurs, the unit attempts to reestablish a baseline by momentarily setting PEEP to 0 cm H₂O and suspending triggered breaths. This interruption lasts no longer than 2 breath cycles. The operator should also check for leaks in the hose and tubes; patient airway and exhalation valve. If recalibration is successful, the alarm will automatically cancel. If it cannot, the patient should be manually ventilated. Replace the unit and send it on for service</p> <p><i>Mitigation/Info: Attempted Self-Calibration, Momentarily Disabling Triggers and PEEP, Check Circuit for Leak/Disconnects, Check Tube Placement/Cuff</i></p> <p>**Replace/Service Ventilator**</p>
2062	<p>Exhalation Fault</p> <p>The airway pressure (P_{aw}) measured at the end of expiration is > 5 cm H₂O above the baseline pressure (PEEP pressure). This is typically caused by a restriction of the exhalation valve or an occlusion/kink in one or more of the breathing circuit tubes or hose. If the breathing circuit tubes appear to be intact, the circuit should be replaced to eliminate the possibility of a bad exhalation valve. If the combination does not resolve, the operator should manually ventilate the patient. Replace the unit and send it in for service.</p> <p><i>Mitigation/Info: Check Circuit for Kinked Hose/Tube, Check for Blocked Exhalation Valve, Replace Circuit, Replace/Service Ventilator</i></p> <p>**Manually Ventilate Patient**</p>

Service Code	Alarm Name/Mitigation/Resolution
2070	<p>Airway Pressure High</p> <p>The P_{aw} meets or is greater than the High Airway Pressure Limit for 2 consecutive breaths. When this occurs, flow decelerates to maintain P_{aw} at the High Airway Pressure Limit for the duration of the breath (inspiratory time). The operator should check for kinks or blockage of the breathing circuit, exhalation valve, or patient airway. In some instances, the cause can be an accumulation of secretions in the airway which will require suctioning to clear. The operator should also assess if the patient is fighting the ventilator (dissynchrony) or if the High Airway Pressure Limit is set too low.</p> <p><i>Mitigation/Info: Pressure Exceeds Limit Setting, Check Circuit for Kinked Hose/Tube, Check for Airway Obstructions, Suction Airway if Necessary, PIP High Limit Set Too Low?</i></p> <p>**Manually Ventilate Patient**</p>
2071	<p>Low Airway Pressure</p> <p>The P_{aw} is less than the Low Airway Pressure Limit for 2 consecutive breaths. The operator should check for leaks/disconnects in the breathing circuit, patient airway, or a failure of the exhalation valve. The operator should also assess if the patient is breathing with the ventilator or if the Low Airway Pressure Limit is set too high. If these mitigations do not resolve the alarm condition, then the ventilator should be replaced and sent in for service.</p> <p><i>Mitigation/Info: Check Patient Connection, Check Circuit for Loose Hose/Tube, Check Exhalation Valve, Check Tube Placement/Cuff, Is High Limit Set Correctly?</i></p> <p>**Manually Ventilate Patient**</p>
2072	<p>High Tidal Volume</p> <p>Operating with a pressure target and the delivered tidal volume exceeds the operator defined limit for 2 consecutive breaths. This can be caused by a leak in the patient connection or breathing circuit. When the ventilator is not able to reach the pressure target, flow increases to compensate which leads to a high delivered tidal volume. It is critical to set this alarm with infant and pediatric patients given the high resistance airways used with these patients can provide a false airway pressure even when the patient has extubated or decannulated. The operator should check for leaks/disconnects in the breathing circuit, patient airway, or a failure of the exhalation valve. The operator should also assess if the patient is anxious and breathing deeply or if the High Tidal Volume Limit is set too low. If a replacement is available, the operator should replace the breathing circuit.</p> <p><i>Mitigation/Info: Check Patient Connection, Check Circuit for Loose Hose/Tube, Check Exhalation Valve, Check Tube Placement/Cuff, Is High Limit Set Correctly?</i></p> <p>**Monitor Patient**</p>
2073	<p>Low Tidal Volume</p> <p>Operating with a pressure target and the delivered tidal volume does not reach the operator defined limit for 2 consecutive breaths. When this occurs, flow decelerates to maintain the P_{aw} at airway pressure limit for the duration of the breath (inspiratory time). If the PIP setting is set properly, the breath should be greater than the low limit (provided it is set properly as well). The operator should check for kinks or blockage of the breathing circuit or patient airway. In some instances, the cause can be an accumulation of secretions in the airway which will require suctioning to clear. The operator should also assess if the patient is fighting the ventilator (dissynchrony) or if the High Airway Pressure Limit is set too low.</p> <p><i>Mitigation/Info: Check Circuit for Kinked Hose/Tube, Check For Airway Obstruction, Suction Airway If Necessary, If Low Limit Set Correctly?</i></p> <p>**Manually Ventilate Patient**</p>

Service Code	Alarm Name/Mitigation/Resolution
2074	<p>High Breath Rate</p> <p>The actual breathing rate (set rate plus spontaneous patient rate) exceeds the high alarm limit. This can be caused by the patient breathing too fast due to anxiety or pending respiratory failure. It can also be caused by autotriggering due to a leak or when the spontaneous/assisted breath trigger is set too close to the baseline pressure (PEEP). The operator should check for leaks/disconnects in the breathing circuit, patient airway, or a failure of the exhalation valve. The operator should also assess if the patient is anxious and breathing deeply or if the High Tidal Volume Limit is set too low. If a replacement is available, the operator should replace the breathing circuit.</p> <p><i>Mitigation/Info: Check for Loose Hose/Tube, Is Trigger Lever Too Sensitive? Is High Alarm Limit Set Correctly?</i></p> <p>**Consult Physician**</p>
2075	<p>Low Breath Rate/Apnea</p> <p>The actual breathing rate (set rate plus spontaneous patient rate) is less than the low alarm limit. This can be caused by the patient not breathing or breathing at a rate less than the limit. If the spontaneous/assisted breath trigger is not sensitive enough, the patient may not be able to trigger breaths. The operator should also determine if the low rate is set too high for the patient.</p> <p><i>Mitigation/Info: Is Patient Breathing Spontaneously?, If Trigger Level Sensitive Enough?, Is Low Alarm Limit Set Correctly?, Increase Breath Support</i></p> <p>**Manually Ventilate Patient**</p>
2076	<p>Apnea</p> <p>The spontaneous breathing rate is less than the low alarm limit. This alarm only occurs in CPAP and CPAP-NPPV. This can be caused by the patient not breathing or breathing at a rate less than the limit. The apnea backup ventilation starts automatically. The operator should set the mode to AC or SIMV. The Rate and Tidal Volume/Pressure targets should also be set.</p> <p><i>Mitigation/Info: Apnea Backup Ventilation Started, Set Mode to AC or SIMV, Set Rate and Tidal Volume/Pressure Target</i></p> <p>**Manually Ventilate Patient**</p>
2090	<p>PEEP Not Met/Circuit Leak</p> <p>P_{aw} drops below the PEEP setting by 2 cm H₂O during the expiratory phase of the breath. This can be caused by a leak in the breathing circuit, exhalation valve, or patient airway. The operator should check the breathing circuit and exhalation valve to assure that all connections are tight. When the circuit appears damaged or is suspect, it should be replaced. The operator should also check if there is a leak around the cuff of the patient's airway. If these mitigations do not resolve the alarm condition, then the ventilator should be replaced and sent in for service.</p> <p><i>Mitigation/Info: Check Patient Connection, Check Circuit For Loose Hose/Tube, Check Exhalation Valve, Check Tube Placement/Cuff</i></p> <p>**Replace Circuit**</p>
2095	<p>Insufficient Flow</p> <p>The pressure target is not reached during the inspiratory period during pressure targeted ventilation. Typically, this can occur when the Rise Time is set too slow for the patient and their respiratory mechanics. Decrease the Rise Time and check the circuit and exhalation valve for leaks or disconnects. If the flow cannot be adjusted appropriately, then the patient should be ventilated using volume targeted ventilation.</p> <p><i>Mitigation/Info: Pressure Target Not Met, Decrease Rise Time, Press/Hold BPM Button</i></p> <p>**Ventilate With Volume Target**</p>

Service Code	Alarm Name/Mitigation/Resolution
2100	<p>Patient Disconnect</p> <p>The P_{aw} fails to exceed the PEEP setting by ~ 7 cm H_2O. When this occurs, the operator should quickly check the patient connection, breathing circuit connections, and the exhalation valve. At times, this alarm can be caused by the patient breathing with the ventilator during inspiration, which prevents the P_{aw} from passing the minimum pressure. While resolving the alarm condition, the operator should be sure to manually ventilate the patient.</p> <p><i>Mitigation/Info: Check Patient Connection, Check Circuit For Loose Hose/Tube, Check Exhalation Valve, Patient Breathing With Ventilator?, Replace Circuit</i></p> <p>**Manually Ventilate Patient**</p>
2170	<p>Spontaneous Breath-PIP High</p> <p>The P_{aw} exceeds the High PIP Limit setting during 2 consecutive spontaneous breaths. When this occurs, the operator should quickly check for kinked hoses/tubes and check for airway obstruction. The patient should be suctioned if necessary. The operator should also check if the High PIP Limit is set correctly. While resolving the alarm condition, the operator should manually ventilate the patient.</p> <p><i>Mitigation/Info: Pressure Exceeds Limit Setting, Check Circuit for Kinked Hose/Tube, Check for Airway Obstruction, Suction Airway If Necessary, PIP High Limit Set Too Low?</i></p> <p>**Manually Ventilate Patient**</p>
2171	<p>Spontaneous Breath-PIP Low</p> <p>The P_{aw} exceeds the Low PIP Limit setting during 2 consecutive spontaneous breaths. When this occurs, the operator should quickly check circuit for loose hoses/tubes and check the exhalation valve and the tube placement/cuff. The operator should also check if the Low PIP Limit is set correctly. While resolving the alarm condition, the operator should manually ventilate the patient.</p> <p><i>Mitigation/Info: Check Circuit for Loose Hose/Tube, Check Exhalation Valve, Check Tube Placement/Cuff, Is Low Limit Set Correctly?</i></p> <p>**Manually Ventilate Patient**</p>
2172	<p>Spontaneous Breath-V_T High</p> <p>The High V_T Limit is exceeded during 2 consecutive spontaneous breaths. When this occurs, the operator should quickly check the patient connection, airway placement, breathing circuit for loose hoses/tubes, and the exhalation valve. The operator should also check if the High V_T Limit is set correctly. While resolving the alarm condition, the operator should manually ventilate the patient.</p> <p><i>Mitigation/Info: Check Circuit for Loose Hose/Tube, Check Exhalation Valve, Check Tube Placement/Cuff, Is High Limit Set Correctly?</i></p> <p>**Manually Ventilate Patient**</p>
2173	<p>Spontaneous Breath-V_T Low</p> <p>The Low V_T Limit is not achieved during 2 consecutive spontaneous breaths. When this occurs, the operator should quickly check for kinked hoses/tubes and check for airway obstruction. The patient should be suctioned if necessary. The operator should also check if the Low V_T Limit is set correctly. While resolving the alarm condition, the operator should manually ventilate the patient.</p> <p><i>Mitigation/Info: Check Circuit for Kinked Hose/Tube, Check For Airway Obstruction, Suction Airway If Necessary, Is Low Limit Set Correctly?</i></p> <p>**Manually Ventilate Patient**</p>
2300	<p>Pulse Ox Module Failed</p> <p>The pulse oximeter module fails while in use. There is no operator intervention. When the alarm is active, "-- --" will display in the HR and SpO_2 windows. Pressing the MUTE/CANCEL button silences the alarm for 30 seconds. To resolve the alarm, remove the probe from the unit and put the pulse oximeter in standby (<i>stby</i>).</p> <p><i>Mitigation/Info: Internal Failure, SpO_2/HR Not Available, Turn Off Pulse Ox</i></p> <p>**Replace/Service Ventilator**</p>

Service Code	Alarm Name/Mitigation/Resolution
2301	<p>Internal Communication Failed</p> <p>The communication between the pulse oximeter and the unit fails. When this occurs, the operator is required to turn off the pulse oximeter to end the alarm condition. When this is done, <i>stby</i> appears in the data windows for SpO₂ and HR as those parameters are no longer available. When appropriate, the operator should replace the ventilator and send it for service.</p> <p><i>Mitigation/Info: Pulse Ox Module Failure, SpO₂/HR Not Available, Turn Off Pulse Ox</i></p> <p>**Replace/Service Ventilator**</p>
2314	<p>SpO2 Sensor Off Patient</p> <p>An operating sensor loses the patient signal. The most common cause is when the sensor disconnects from the patient or is misaligned with the sensor site. This alarm can also be caused by poor perfusion at the sensor which doesn't allow for a reading. In these cases, try another site. Replace the sensor if another sensor is available. If the alarm condition cannot be resolved, the operator should put the pulse oximeter monitor in standby (<i>stby</i>).</p> <p><i>Mitigation/Info: Check Pulse Ox Sensor Site, Check Patient For Peripheral Pulse, Change Placement, Check Sensor Operation, Replace Sensor</i></p> <p>**Turn Off Pulse Ox Monitoring**</p>
2401	<p>SpO2 Low</p> <p>The SpO₂ value drops below the Low SpO₂ Limit. The default value for the limit is 94%. Corrective actions are increasing oxygenation by increasing the FIO₂ or PEEP settings. PEEP should only be changed based on consultation with the attending physician. When using low flow oxygen, the operator should increase the flow of oxygen into the optional low flow O₂ Reservoir.</p> <p><i>Mitigation/Info: SpO₂ Below Limit, Increase FIO₂, Check O₂ Supply, Increase PEEP Per Physician</i></p> <p>**Consult Physician**</p>
2410	<p>Heart Rate High</p> <p>The heart rate is greater than the High Heart Rate Limit. The default value for the limit is 120 beats/minute. The operator should consult with the attending physician on how best to reduce the heart rate to an acceptable level.</p> <p><i>Mitigation/Info: Heart Rate Above Limit</i></p> <p>**Consult Physician**</p>
2411	<p>Heart Rate Low (Pulse Rate Low)</p> <p>The heart rate is less than the Low Heart Rate Limit. The default value for the limit is 40 beats/minute. The operator should consult with the attending physician on how best to increase the heart rate to an acceptable level.</p> <p><i>Mitigation/Info: Heart Rate Below Limit</i></p> <p>**Consult Physician**</p>
2421	<p>Input Protection Circuit Failed</p> <p>There is a failure of the input protection circuit and the unit is able to operate. The alarm will continue until the unit is turned off. The operator can mute the alarm for 30 seconds by pushing the MUTE/CANCEL button. The operator should replace the unit and send it in for service.</p> <p><i>Mitigation/Info: Input Protection Circuit Failure, Power System Needs Repair, Internal Battery Operation</i></p> <p>**Replace/Service Ventilator**</p>
2423	<p>Power Circuit Hardware Fault</p> <p>The internal power circuit has failed and external power is connected but cannot be used. The fault cannot be repaired by the operator. Pressing the MUTE/CANCEL button silences the audible alarm for 30 seconds.</p> <p><i>Mitigation/Info: Power System Needs Repair, Internal Battery Operation</i></p> <p>**Replace/Service Ventilator**</p>

ALARMS

Service Code	Alarm Name/Mitigation/Resolution
2430	<p>Low Battery</p> <p>The unit detects that there is ≤ 5 minutes of battery operation remaining and external power is not connected. The operator should immediately seek a source of external power and/or plan to provide manual ventilation. Attaching external power will immediately clear the alarm, though a Low Priority alarm will be maintained until the internal battery is recharged so that the unit can provide 30 minutes of operating time (~5 to 10 minutes).</p> <p><i>Mitigation/Info: Less Than 5 Minutes Operation, Connect External Power, Assure Ability to Manually Ventilate</i></p> <p>**Replace/Service Ventilator**</p>
2450	<p>Battery Fault-No External Power Connected</p> <p>The battery temperature reaches 70°C (158°F), which is 5°C from its maximum operating temperature using the internal battery and external power is not connected. When the battery temperature reaches 75°C (167°F), the battery will shut down to prevent failure and the unit will sound a High Priority alarm and shut down. If possible, the operator should provide a source of external power which would allow operation to continue at the current and higher temperatures. In addition, the unit should be removed from the soft case (if purchased) which acts as insulation. Shading the patient and ventilator from direct sunlight may also help reduce the battery temperature.</p> <p><i>Mitigation/Info: Battery Within 5°C of High Limit, Remove Padded Case, Assure External Power Available, Assure Ability to Manually Ventilate, Shade Patient and Ventilator</i></p> <p>**Move to Cooler Location**</p>
2455	<p>Battery Fault-No External Power Connected</p> <p>The unit is not able to communicate with the internal battery. When this occurs, the device does not know the current charge in the battery and operation could stop at any time. To continue operation, the operator should connect external power and assure the ability to manually ventilate the patient. When external power is connected, the alarm priority decreases to Low Priority.</p> <p><i>Mitigation/Info: Battery Communication Failure!, Connect External Power, Assure Ability to Manually Ventilate Patient</i></p> <p>**Replace/Service Ventilator**</p>
3001	<p>Compressor Fault</p> <p>The compressor fails to operate or fails to provide the flow required to deliver a breath within $\pm 10\%$ of the current settings, HP O₂ is available to provide ventilation and the operator has set the FIO₂ to 100%. While operating in this state, the operator should assure an adequate supply of HP O₂. Failure to maintain the HP O₂ supply will result in a High Priority alarm.</p> <p><i>Mitigation/Info: Assure 55 psig O2, O2 Operation Only!</i></p> <p>**Replace/Service Ventilator**</p>
3002	<p>Compressor Fault</p> <p>Communication between the compressor controller and SPM is lost, HP O₂ is available to provide ventilation, and the operator has set the FIO₂ to 100%. While operating in this state, the operator should assure an adequate supply of HP O₂. Failure to maintain the HP O₂ supply will result in a High Priority alarm.</p> <p><i>Mitigation/Info: Assure 55 psig O2, O2 Operation Only!</i></p> <p>**Replace/Service Ventilator**</p>

Service Code	Alarm Name/Mitigation/Resolution
3011	<p>O2 Valve Fault</p> <p>The signal to the O₂ valve is outside of the calibration range for the required flow rate, the compressor is available to provide ventilation, and the operator has acknowledged that ventilation is being provided using the compressor by setting the FIO₂ to 21%. While operating in this state, the operator should monitor the SpO₂ to assure that adequate oxygenation is maintained. If low flow oxygen is available, it can be entrained through the Fresh Gas/Emergency Air Intake using the optional O₂ Reservoir. Maintain an acceptable SpO₂ by adjusting the oxygen supply up or down to increase or decrease the amount of oxygen delivered to the patient.</p> <p><i>Mitigation/Info: Compressor Operation Only!, Keep FIO₂ at 21%, Connect Low Flow O2, Monitor SpO₂</i></p> <p>**Replace/Service Ventilator**</p>
3012	<p>O2 Valve Fault</p> <p>Communication between the O₂ Valve is lost, the compressor is available to provide ventilation, and the operator has set the FIO₂ to 21%. While operating in this state, the operator should monitor the SpO₂ to assure that adequate oxygenation is maintained. If low flow oxygen is available, it can be entrained through the Fresh Gas/Emergency Air Intake using the optional O₂ Reservoir. Maintain an acceptable SpO₂ by adjusting the oxygen supply up or down to increase or decrease the amount of oxygen delivered to the patient.</p> <p><i>Mitigation/Info: Operation Switched to Compressor!, Keep FIO₂ at 21%, Connect Low Flow O2, Monitor SpO₂</i></p> <p>**Replace/Service Ventilator**</p>
3030	<p>Fresh Gas Intake Fault</p> <p>The Fresh Gas/Emergency Air Intake is blocked so that the compressor is not able to deliver breaths within 10% of the current settings, HP O₂ is available to support ventilation, and the operator has set the FIO₂ to 100%. To clear the alarm, clear the blockage and set the FIO₂ back to the original value. If the blockage is cleared, operation with the compressor will restart. If the blockage is not cleared, the alarm will resound; set the FIO₂ to 100%, continue ventilation, and assure an adequate supply of HP O₂. (It is possible for this alarm to be a false alarm that is triggered in a very high vibration environment.)</p> <p><i>Mitigation/Info: O2 Valve Operation, Clear Blocked Intake & Retry Compressor, Keep FIO₂ at 100%, Monitor SpO₂</i></p> <p>**Replace/Service Ventilator**</p>
3031	<p>Fresh Gas Intake Fault</p> <p>The Fresh Gas/Emergency Air Intake is blocked but is still capable of delivering breaths within 10% of the current settings. This could be caused by an external blockage or a dirty external or internal filter. If the blockage is cleared, the alarm will automatically cancel.</p> <p><i>Mitigation/Info: Clear Restricted Intake, Patient Breathing with Ventilator?</i></p> <p>**Replace/Service Ventilator**</p>
3032	<p>Fresh Gas Intake Fault</p> <p>Communication between the Fresh Gas/Emergency Air Intake pressure sensor is lost. Normal operation will continue, but if the condition is not cleared by powering off and restarting, the unit should be sent in for service. When used during this alarm condition, the operator should be sure to keep the Fresh Gas/Emergency Air Intake clear and assure that external filters are checked regularly.</p> <p><i>Mitigation/Info: Intake Pressure Sensor Failure, Unable to Detect Filter Obstruction</i></p> <p>**Replace/Service Ventilator**</p>

Service Code	Alarm Name/Mitigation/Resolution
3041	<p>O2 Supply Pressure High</p> <p>The oxygen supply pressure is ≥ 75 psig and < 80 psig. The alarm automatically cancels when the supply pressure drops below 66 psig. Pressures above 80 psig could result in a catastrophic failure, harm to the patient, and/or damage to the unit. The operator should seek to reduce the oxygen supply pressure; sometimes this requires replacing the regulator which is not functioning as required. If the pressure cannot be reduced and a low flow device like a flow meter is available, the operator can provide supplemental oxygen via the optional low flow O₂ Reservoir. If not, the operator should monitor the HP O₂ supply pressure and assure that the pressure does not rise further.</p> <p><i>Mitigation/Info: Decrease O₂ Supply Pressure, Replace Regulator, Connect Low Flow O₂, Monitor SpO₂</i> <i>**Monitor O2 Supply Pressure**</i></p>
3091	<p>Incomplete Exhalation</p> <p>The exhaled flow from the patient continues throughout the expiratory period causing the expiratory control valve to cycle throughout the period to maintain the baseline pressure. When this occurs, the operator should increase the expiratory period by decreasing the inspiratory time, decreasing the breathing rate, or both. The physician should also be consulted as this alarm is an indication that autoPEEP is occurring.</p> <p><i>Mitigation/Info: Incomplete Exhalation, Increase Expiratory Time, Decrease Inspiratory Time, Decrease Respiratory Rate</i> <i>**Consult Physician**</i></p>
3092	<p>Patient Inspiratory Demand Not Met</p> <p>The end Inspiratory P_{aw} is < -1.0 cm H₂O for 3 consecutive breaths. (3 breaths are required to eliminate nuisance alarms when the patient takes a single deep breath.) This can occur due to changes in the patient's status, where the patient will attempt to inspire more gas than what is currently being delivered. When this occurs, the operator should note if the patient is breathing or fighting with the vent. The operator should increase the flow rate (by decreasing the inspiratory time) and/or reduce the rise time. The physician should be consulted.</p> <p><i>Mitigation/Info: Patient Breathing/Fighting with Vent?, Increase Flow Rate or Reduce Rise Time, Adjust Alarm Settings if Required, Consult Physician</i> <i>**Manually Ventilate Patient**</i></p>
3110	<p>RTC Battery Fault</p> <p>The real-time clock (RTC) battery is $< \sim 2.5$ volts. The alarm condition is checked at start up and if this alarm occurs, the unit is safe to operate but the operator should look to take the unit out of service when appropriate and send it for service. Changing the battery requires opening the unit and should only be done by a trained service technician. The RTC battery provides power for the storage of critical information used by the ventilator during startup.</p> <p><i>Mitigation/Info: RTC Battery Low, Schedule Service Immediately</i> <i>**Replace/Service Ventilator**</i></p>
3120	<p>Self Check Fault</p> <p>Start up when the preselected number of days has elapsed from the last calibration. When appropriate, the unit should be sent for service. The Low Priority message serves as a reminder. Calibration is due every 365 days or 1500 hours of service. Operators should schedule the unit for service as soon as possible.</p> <p><i>Mitigation/Info: Calibration Due, Schedule Service Immediately</i> <i>**Replace/Service Ventilator**</i></p>

Service Code	Alarm Name/Mitigation/Resolution
3130	<p>Ambient Pressure Fault (Excessive Altitude Sensor Failure)</p> <p>The ambient pressure transducer fails. When this occurs, the unit is no longer able to automatically compensate for changes in altitude especially in situations where the ambient pressure could change rapidly as during air transport. When used in these conditions, the operator should monitor the airway pressure and reduce the tidal volume to maintain the airway pressure as altitude is increased. During descent, the tidal volume should be increased to maintain P_{aw} if it was adjusted while in altitude. Operators should also monitor chest rise and breath sounds to assure adequate ventilation.</p> <p><i>Mitigation/Info: Barometric Pressure Sensor, Altitude Compensation Disable, Maintain Airway Pressure, Check Patient Chest Rise, Avoid Use At Varying Altitude</i></p> <p>**Replace/Service Ventilator**</p>
3131	<p>Ambient Pressure Fault (Excessive Altitude)</p> <p>The ambient pressure transducer detects an altitude > 25,000 feet (7620 meters). Beyond this altitude, compensation remains fixed at the 25,000 ft compensation level. The operator should monitor the P_{aw} and reduce the tidal volume as altitude increases. During descent, the tidal volume should be increased to its original value once the unit has returned to the compensated altitude. Where possible, cabin pressure should be maintained in the compensated range.</p> <p><i>Mitigation/Info: Excessive Altitude Detected, Beyond Altitude Compensation Limit, Maintain Airway Pressure, Check Patient Chest Rise, Monitor Ventilator/Patient</i></p> <p>**Reduce Altitude**</p>
3132	<p>Ambient Pressure Fault</p> <p>The ambient pressure transducer detects an altitude of < -2,000 feet below sea level (610 meters, 15.8 psig, or 1089 mb). This state can be caused by use in subterranean rescue operations or mistaken use in a hyperbaric chamber. Beyond this pressure level, compensation remains fixed at the -2,000 ft level</p> <p>Note: The unit is not intended for use in hyperbaric chambers</p> <p><i>Mitigation/Info: High Barometric Pressure Detected, Beyond Compensation Limit, Maintain Airway Pressure, Check Patient Chest Rise, Monitor Ventilator/Patient</i></p> <p>**Reduce Ambient Pressure**</p>
3140	<p>Operational Temperature Fault (Excessive Temperature High)</p> <p>The ambient temperature exceeds the normal operating range (> 131°F, 55°C) for the ventilator. The unit allows operation at these temperatures, but alerts the operator to the condition. Operating above the specified range can affect the longevity of the internal battery and the duration of operating time. When operating at high temperatures, the operator should remove the softcase (if purchased), which insulates and increases the ventilator's internal temperature.</p> <p><i>Mitigation/Info: High Temperature Detected, Remove Padded Case</i></p> <p>**Monitor Ventilator**</p>
3141	<p>Operational Temperature Fault (Excessive Temperature Low)</p> <p>The ambient temperature exceeds the normal operating range (< 14°F, -10°C) for the ventilator. The unit allows operation at these temperatures, but alerts the operator to the condition. Operating above the specified range can affect the longevity of the internal battery and the duration of operating time. At extreme cold temperatures, operating time can be significantly reduced. When operating at low temperatures, the operator should use the softcase (if purchased), which insulates and increases the ventilator's internal temperature.</p> <p><i>Mitigation/Info: Low Temperature Detected, Use Padded Case</i></p> <p>**Monitor Ventilator**</p>

Service Code	Alarm Name/Mitigation/Resolution
3143	<p>Self Check Fault</p> <p>The failure of the internal temperature sensors. When this occurs, the unit is no longer able to detect if it is operating outside the allowable temperature range. If operating inside the standard temperature range -25°C to 49°C (-13°F to 120°F), there is no effect on operation. If operating outside this range, the operator should monitor the unit continuously. When appropriate, the operator should replace the ventilator and send it for service.</p> <p><i>Mitigation/Info: Temperature Sensor Fault, Temperature Changes Do Not Affect Autocal Cycle, Schedule Service Immediately</i></p> <p>**Replace/Service Ventilator**</p>
3300	<p>SpO2 Shutdown (MS 11 Failure-Monitor Not In Use)</p> <p>The pulse oximeter module fails and the operator has turned off pulse oximeter monitoring acknowledging the condition. When this is done, <i>stby</i> appears in the data windows for SpO₂ and HR as those parameters are no longer available. When appropriate, the operator should replace the ventilator and send it in for service.</p> <p><i>Mitigation/Info: Internal Failure, SpO₂,HR Not Available</i></p> <p>**Replace/Service Ventilator**</p>
3301	<p>SpO2 Shutdown (Communication Failure EMC-Pulse Ox-Monitor Not In Use)</p> <p>Communication between the pulse oximeter module and the unit fails and the operator has turned off pulse oximeter monitoring acknowledging the condition. When this is done, <i>stby</i> appears in the data windows for SpO₂ and HR as those parameters are no longer available. When appropriate, the operator should replace the ventilator and send it in for service.</p> <p><i>Mitigation/Info: Pulse Oximeter Failure, SpO₂,HR Not Available</i></p> <p>**Replace/Service Ventilator**</p>
3310	<p>No SpO2 Sensor Connected (No Sensor Connected)</p> <p>The pulse oximeter detects that no SpO₂ sensor is connected after a period of successful operation.</p> <p>Note: During start up, the unit automatically detects if a sensor is connected. If it is, the unit begins operation with the pulse oximeter active. If no sensor is detected, the unit turns off this function.</p> <p>If the sensor is properly connected, this failure can also be the result of a broken or defective sensor. If the alarm condition cannot be resolved, the operator should remove the sensor and turn off pulse oximetry monitoring in the User Menu by placing it in standby (<i>stby</i>).</p> <p><i>Mitigation/Info: Check Pulse Ox Sensor, Check Sensor/Ventilator Connection, Reinsert Sensor, Cable/Sensor Damaged?, Replace Sensor</i></p> <p>**Turn Off Pulse Ox Monitoring**</p>
3311	<p>Defective Sensor</p> <p>The pulse oximeter cannot identify the connected sensor or the sensor has failed. Cause for this alarm include broken sensor cable, inoperative LEDs and/or faulty detector. If the alarm condition cannot be resolved, the operator should suspend pulse oximetry monitoring by placing it in standby (<i>stby</i>).</p> <p><i>Mitigation/Info: Check Pulse Ox Sensor, Check Sensor/Ventilator Connection, Reinsert Sensor, Cable/Sensor Damaged?, Replace Sensor</i></p> <p>**Turn Off Pulse Ox Monitoring**</p>
3312	<p>SpO2 Pulse Search</p> <p>The pulse oximeter is searching for a pulse. If values are not displayed within 30 seconds, disconnect and reconnect the sensor and reapply to the patient. If pulse search continues, remove the sensor and replace on a better perfused site. Replace the sensor if another sensor is available. If the alarm condition cannot be resolved, the operator should suspend pulse oximetry monitoring by placing it in standby (<i>stby</i>).</p> <p><i>Mitigation/Info: Please Wait, Check Sensor Placement, Change Placement, Minimize Patient Movement, Check Sensor Operation/Replace</i></p> <p>**Turn Off Pulse Ox Monitoring**</p>

Service Code	Alarm Name/Mitigation/Resolution
3313	<p>SpO2 Signal Interference An outside signal or energy source prevents accurate reading by the device. When this occurs, the patient should be moved from the location or pulse oximeter turned off. <i>Mitigation/Info: External Signal Interfering With Measurement, Remove Patient from Location</i> **Turn Off Pulse Ox Monitoring**</p>
3315	<p>Too Much Ambient Light There is too much ambient light on the SpO₂ sensor or there is inadequate tissue covering the sensor detector. Most often, this alarm condition can be resolved by shielding the sensor from ambient light. <i>Mitigation/Info: Shield Sensor From Light, Change Sensor Placement, Check Sensor Operation, Replace Sensor</i> **Turn Off Pulse Ox Monitoring**</p>
3316	<p>Invalid SpO2 Sensor (Unrecognized Sensor) The pulse oximeter does not recognize the connected sensor. The alarm can also occur when there is a broken sensor cable, inoperative LEDs, a fault is detected, and/or the sensor has failed. To resolve the alarm condition, the sensor should be replaced. If the alarm condition cannot be resolved, the operator should turn off pulse oximetry monitoring by placing it in standby (<i>stby</i>). <i>Mitigation/Info: Invalid Pulse Ox Sensor, Replace Sensor</i> **Turn Off Pulse Ox Monitoring**</p>
3317	<p>Low SpO2 Perfusion (Low Perfusion) The amplitude of the arterial pulsation is weak. Low perfusion typically occurs in patients with poor circulation or when the sensor is applied to the same limb as the noninvasive blood pressure (NIBP) cuff. To resolve the alarm condition, move the sensor to a better perfused site or to another limb if the interference is the NIBP cuff. <i>Mitigation/Info: Arterial Pulsation Weak, Check Sensor Placement, Check Sensor Operation</i> **Turn Off Pulse Ox Monitoring**</p>
3318	<p>Low SpO2 Perfusion (Poor SpO2 Signal) The pulse oximeter determines the quality of the input signal is low due to excessive motion or artifact. To resolve the alarm condition, minimize patient movement and make sure the sensor is properly applied. <i>Mitigation/Info: Signal Artifact, Minimize Patient Movement, Check Sensor Placement, Check Sensor Operation</i> **Turn Off Pulse Ox Monitoring**</p>
3421	<p>External Power Fail/Disconnect The external power (either AC or DC) drops below minimum level (~11 VDC as supplied by either the AC/DC Power Supply or a direct DC source) or power is intentionally disconnected. Since the unit is designed to operate with either external power or using its internal battery, this is a Low Priority alarm that clears when the operator presses the MUTE/CANCEL button. Pressing the MUTE/CANCEL button is the operator's acknowledgment that the unit is operating on internal battery. If this alarm occurs and the operator believes that the unit is still connected to external power, the operator should investigate the external power source. <i>Mitigation/Info: Internal Battery Operation, Check Power Connection/Supply, Monitor Battery Status</i> **Replace/Service Ventilator**</p>
3422	<p>Missing Battery The internal battery is removed or communication between the battery and CPU has failed. When external power is applied, the unit is capable of operation; however, loss of external power will result in loss of ventilation and a High Priority alarm. Operating in this state should only be done when no other alternatives are available. <i>Mitigation/Info: No Battery Detected, DO NOT Remove External Power!, Maintain External Power!</i> **Replace/Service Ventilator**</p>

Service Code	Alarm Name/Mitigation/Resolution
3423	<p>Battery Charge Circuit Failed</p> <p>The Battery Charge Circuit has failed. Under this condition, the battery cannot be charged. When external power is applied, the unit is capable of operation; however, loss of external power will result in loss of ventilation and a High Priority alarm. Operating in this state should only be done when no other alternatives are available</p> <p><i>Mitigation/Info: Power System Needs Repair, Battery Cannot Charge, Maintain External Power!</i></p> <p>**Replace/Service Ventilator**</p>
3430	<p>Low Battery (Low Battery-Warning)</p> <p>The unit detects that there are ≤ 30 minutes of battery operation remaining and no external power is connected. The operator should seek a source of external power and/or plan to provide manual ventilation. Attaching external power will immediately clear the 3430 alarm. Alarm 3431 will occur in its place.</p> <p><i>Mitigation/Info: Less Than 30 Minutes Operation, Connect External Power, Assure Ability to Manually Ventilate</i></p> <p>**Replace/Service Ventilator**</p>
3431	<p>Low Battery</p> <p>External power is connected to a unit that has an internal battery that has drained to a Low Battery status. The unit is warning the operator that in the event of an external battery failure, the unit has ≤ 30 minutes of backup. This alarm will resolve when the internal battery charge has approximately > 30 minutes of operation. The operator must maintain constant monitoring of the device and the patient during this period.</p> <p><i>Mitigation/Info: Less Than 30 Minutes Internal Backup, Operating With External Power, Continue Charging With External Power, Assure Ability to Manually Ventilate</i></p> <p>**Replace/Service Ventilator**</p>
3441	<p>External Power Failed (External Voltage High)</p> <p>The supplied DC power is > 33 VDC. When this occurs, the unit automatically switches to operation using the internal battery. If the supplied voltage drops to < 30 VDC, the unit automatically switches to operation using external power. If the external power source is known to be good, then the AC/DC Power Supply may be faulty and need of replacement.</p> <p><i>Mitigation/Info: External Voltage Too High, Internal Battery Operation, Check/Replace Power Supply</i></p> <p>**Remove DC Connection**</p>
3442	<p>External Power Failed (Insufficient Current)</p> <p>The external power supply has insufficient current. When this occurs, the unit automatically switches to operation using the internal battery. If the external power source is known to be good, then the AC/DC Power Supply may be faulty and need of replacement.</p> <p><i>Mitigation/Info: Internal Battery Operation, Check/Replace Power Supply, Change Power Source</i></p> <p>**Remove DC Connection**</p>
3444	<p>External Power Failed</p> <p>The voltage polarity is reversed when the unit is attached to an external DC source. When this occurs, the unit automatically switches to operation using the internal battery. This condition is most likely caused by a faulty DC source. The operator should seek an alternate power source.</p> <p><i>Mitigation/Info: DC Voltage Reversed, Internal Battery Operation, Disconnect Power Source</i></p> <p>**Replace Power Source**</p>
3450	<p>Battery Fault (Battery Nearly Too Hot For Discharge-w/External Power Connected)</p> <p>The battery temperature reaches 70°C (158°F), which is 5°C from its maximum operating temperature and external power is connected. When the battery temperature reaches 75°C (167°F), the battery will shut down to prevent failure. When this occurs, the unit will continue operation using external power only. The unit should be removed from the soft case (if purchased) which acts as insulation. Shading the patient and ventilator from direct sunlight may also help reduce the battery temperature.</p> <p><i>Mitigation/Info: Battery Too Hot to Discharge, DO NOT Remove External Power!, Remove Padded Case, Assure Ability to Manually Ventilate Patient, Shade Patient and Ventilator</i></p> <p>**Move to Cooler Location**</p>

Service Code	Alarm Name/Mitigation/Resolution
3451	<p>Battery Fault (Battery Too Hot For Discharge-w/External Power Connected)</p> <p>The battery temperature reaches $\geq 75^{\circ}\text{C}$ (167°F) and external power is connected. Discharging the battery beyond this temperature could destroy the battery and damage the unit. During the alarm condition, the unit will continue operation using external power only. The unit should be removed from the soft case (if purchased) which acts as insulation. Shading the patient and ventilator from direct sunlight may also help reduce the battery temperature.</p> <p><i>Mitigation/Info: Battery Too Hot to Discharge, DO NOT Remove External Power!, Remove Padded Case, Assure Ability to Manually Ventilate Patient, Shade Patient and Ventilator</i></p> <p>**Move to Cooler Location**</p>
3452	<p>Battery Fault (Battery Too Hot For Charging)</p> <p>The battery temperature is $> 45^{\circ}\text{C}$ (122°F). Charging the battery above this temperature could destroy the battery and damage the unit. During the alarm condition, the unit will continue operation using external power and if external power is lost, the unit will operate using internal battery power. The unit should be removed from the soft case (if purchased) which acts as insulation. Shading the patient and ventilator from direct sunlight may also help reduce the battery temperature.</p> <p><i>Mitigation/Info: Battery Does Not Charge when Too Hot, Assure External Power Available, Remove Padded Case, Shade Patient and Ventilator</i></p> <p>**Move to Cooler Location**</p>
3453	<p>Battery Fault (Battery Too Cold For Charging)</p> <p>The battery temperature is $\leq 0^{\circ}\text{C}$ (32°F). Charging the battery below this temperature could destroy the battery and damage the unit. During the alarm condition, the unit continues to operate using external power and if external power is lost, the unit will operate using internal battery power. The soft case (if purchased) should be used because it provides insulation.</p> <p><i>Mitigation/Info: Battery Too Cold To Charge, Assure External Power Available, Use Padded Case</i></p> <p>**Move to Warmer Location**</p>
3455	<p>Battery Fault-With External Power Connected (Battery Communication Failure)</p> <p>The unit is not able to communicate with the internal battery and external power is connected. To continue operation, the unit should remain connected to external power.</p> <p><i>Mitigation/Info: Battery Communication Failure!, DO NOT Remove External Power!, Assure Ability to Manually Ventilate Patient</i></p> <p>**Replace Battery Soon**</p>
3470	<p>Internal Communication (Comm) Failure Fault-PIM Comm</p> <p>The unit is no longer able to communicate with the Power Interface Module (PIM). When this occurs, the operator should monitor operation continuously, seek to replace the ventilator as soon as possible, and assure the ability to manually ventilate the patient.</p> <p><i>Mitigation/Info: Power Management Failure, Assure Ability To Manually Ventilate Patient, Monitor Power Source</i></p> <p>**Replace/Service Ventilator**</p>
3480	<p>SPM Compatibility Fault</p> <p>The unit software detects that it has not been calibrated with the SPM that is inside the unit. This fault occurs when the biomedical technician fails to recalibrate the unit following an SPM change or service. When this occurs, the unit should be removed from use when appropriate and sent in for service.</p> <p><i>Mitigation/Info: Hardware Compatibility Failure, Update Calibration Records</i></p> <p>**Replace/Service Ventilator**</p>

Alarm Turn Off and Cancellation

The operator may decide, based on their clinical assessment, either to turn off or cancel certain alarms that, in the given situation, are considered “nuisance” alarms and are not assisted in the safe management of the patient. Before any such alarms can be turned off or cancelled, the operator will receive a Pop Up message asking them to confirm their understanding that the alarm will no longer be available in current operating session.

Alarm Preemptive Mute upon Power up

When the unit is first powered up, certain patient circuit alarms are preemptively muted for 120 seconds, to allow the operator time to get the patient circuit properly adjusted without nuisance alarms.

Note: During this preemptive mute of this audible alarm, the LED alarm light and alarm message are still indicated.

There is a countdown timer located under the muted alarm symbol, showing how much time of the 120 seconds is remaining. The list of alarms that have this preemptive mute are:

Alarm Number	Alarm Name
2062	Exhalation Fault
2070	Airway Pressure High
2071	Low Airway Pressure
2072	High Tidal Volume
2073	Low Tidal Volume
2074	High Breath Rate
2075	Low Breath Rate/Apnea
2076	Apnea
2090	PEEP Leak
2095	Insufficient Flow
2100	Patient Disconnect
2170	Spontaneous Breath-PIP High
2171	Spontaneous Breath-PIP Low
2172	Spontaneous Breath- V_T High
2173	Spontaneous Breath- V_T Low
2300	Pulse Ox Module Failed
2301	Internal Communication Failed
2314	SpO2 Sensor Off Patient
2401	SpO2 Low
2410	Heart Rate High

Alarm Number	Alarm Name
2411	Heart Rate Low (Pulse Rate Low)
3300	SpO2 Shutdown (MS 11 Failure-Monitor Not In Use)
3301	SpO2 Shutdown (Communication Failure EMV-Pulse Ox-Monitor Not In Use)
3310	No SpO2 Sensor Connected (No Sensor Detected)
3311	Defective Sensor
3312	SpO2 Pulse Search
3313	SpO2 Signal Interference
3315	Too Much Ambient Light
3316	Invalid SpO2 Sensor (Unrecognized Sensor)
3317	Low SpO2 Perfusion (Low Perfusion)
3318	Low SpO2 Perfusion (Poor SpO2 Signal)

Alarm Turn Off at Extreme Range Limits

If the operator sets the following alarm limits to their extreme range, the indicated alarms will be turned off after the Pop Up message confirmation:

1. High Breath Rate (Alarm #2074)
2. PIP Low (Alarms #2071, 2171)
 - a. This changes automatically to *off* in NPPV.
3. V_T High (Alarms #2072, 2172)
 - a. This changes automatically to *off* in NPPV.
4. V_T Low (Alarms #2073, 2173)
 - a. This changes automatically to *off* in NPPV.
5. Low SpO2 (Alarm #2410)
6. High Heart Rate (Alarm #2410)
7. Low Heart Rate (Alarm #2411)

If an alarm has been turned *off* and is then modified, but is not accepted, then the alarm parameter will be set to the values indicated in the following table. This is done to ensure patient safety in the event of an inadvertent value change. These values can be changed by the operator following the parameter change procedures described above.

High Breath Rate	PIP Low	V_T High	V_T Low	Low SpO2	High Heart Rate	Low Heart Rate
99 BPM	3 cm H ₂ O	2000 ml	0 ml	86%	240 BPM	30 BPM

Alarm Cancellation in Alarm Configuration Menu

There are clinical situations where an alarm occurs, and in the operator's clinical judgment, this alarm should be cancelled for the remainder of the unit's operating session. The following constraints apply to this alarm cancellation:

1. Only alarms that have occurred in the current operating session can be cancelled.
2. Alarms which have not occurred since turn on will be indicated with a "--".
3. Cancelled alarms will not be saved in the User Settings for the next session.
4. All cancelled alarms will reappear (if appropriate) when the unit is next turned on. (As an example, the Self Check Fault, calibration due Alarm # 3120, will reappear in the next operating session.)

The following alarms may be cancelled in the Alarm Configuration Menu:

1. Self Check Fault, calibration due (Alarm #3120)
2. RTC Battery Fault (Battery Low) (Alarm #3110)
3. Incomplete Exhalation (Alarm #3110)
4. PEEP Leak (Alarm #2090)
5. Fresh Gas Intake Fault (Alarm #3031)
6. Patient Inspiratory Demand Not Met (Alarm #3092)

Chapter 5

Maintenance

The ZOLL ventilator must be maintained to be ready for immediate use. The device should be incorporated into a regular preventative maintenance program to insure compliance with operating specifications.

Calibration Checks

Calibration checks should be done every 12 months or 1500 service hours, unless significant usage warrants a shorter period between preventative maintenance inspections. The device performs a calibration check as part of the start up routine when the device is powered on. Following 6-months of continuous storage/non-use, or longer, this device should be examined, operationally tested, and its batteries recharged before patient-use is attempted. A complete calibration check should be made by a competent biomedical equipment technician at 12 month/1500 service hour intervals. Calibration checks should be performed as required and the results recorded. A secure record of these calibration checks should be maintained for devices not returned to ZOLL for calibration/maintenance. Calibration checks should also be performed whenever the operator suspects that the unit is not functioning properly or following mass deployment before the device is returned to storage. If the unit being tested fails the calibration check, it should be returned to an authorized ZOLL Service Center or ZOLL for calibration.

Contact an authorized ZOLL Service Center or ZOLL prior to returning this instrument for scheduled maintenance, calibration, or service (Telephone: 1-973-882-1212, email: www.zoll.com). A Returned-Goods-Authorization number (RGA #) will be issued. The RGA # must appear on both the packing slip and address label. This will facilitate better tracking of the returned item and result in improved scheduling and handling.

General Cleaning

Keep the unit and its accessories clean at all times. Never allow grease and/or oil to enter the system or coat its components. Exposed parts should be dried following usage in wet environments. Users are encouraged to clean this device and its accessories at regular intervals and maintain up-to-date records of maintenance and inspections. Internal pneumatic components are sealed, thus routine maintenance is not required. Pressure hose connections should be wiped with a damp, soapy cloth and thoroughly dried with a lint-free cloth. The unit's housing should also be cleaned as necessary with damp, soapy cloth and thoroughly dried with a lint-free cloth. Do not clean with abrasives or chlorinated hydrocarbon cleansers.

High Pressure Hoses

Examine hoses for cracking, discoloration, and disfigurement. Wipe the exterior wall with a damp, soapy cloth. Dry with a lint-free cloth. Examine end connection fittings for damaged threads and sharp edges. Replace if defective, DO NOT attempt to repair.

Warning! Never use oil or grease of any kind with oxygen or compressed gas equipment.

Preventative Maintenance

Routine maintenance should be performed on this instrument at regular intervals and prior to its being placed into service. Routine maintenance should consist of the following:

1. **Storage** -- make sure the ventilator is stored in a clean and dry environment.
2. **Operational checks** -- with the ventilator not connected to a patient, power cycle the ventilator after every 1000 hours of use and using a ventilator circuit and test lung, operate the ventilator at default settings, then change various settings and confirm proper operation, test disconnect, airway pressure, and SpO₂ alarms.
3. **Tubing and hose checks** -- replace crimped, cracked, or worn tubing and hoses as required.
4. **Mechanical components are subject to wear and fatigue over time.** Components will deteriorate more quickly when used continuously. To insure compliance with operating specifications, it is the user's responsibility to insure that periodic preventative maintenance is performed. It is recommended that the In-Field Calibration Check be performed by ZOLL or a certified ZOLL service facility.
5. ZOLL recommends that on a daily basis, the operator examine the breathing circuit for damage or wear including but not limited to cracking, discoloration, or disfigurement. If there is any sign of physical degradation or the unit is indicating breathing circuit problems, the operator should replace with a new breathing circuit.

Removable Foam Filter Replacement

The Removable Foam Filter is located on the right side of the ventilator. It should be inspected and replaced if necessary every 1,000 hours of operation or more frequently if used in dusty environments. Remove the filter using a pair of tweezers or similar tool. Examine the filter for dirt, lint, or general wear. Replace if necessary.
(Part #465-0028-00). DO NOT attempt to clean the filter.

Caution Do not operate the compressor without a filter in place.

Fresh Gas/Emergency Air Intake Disk Filter Replacement

The Fresh Gas/Emergency Air Intake Disk Filter (Part #465-0027-00) is located behind the Removable Foam Filter. This filter provides a second level of filtration to the ambient air that is delivered to the patient. This filter must be checked periodically and replaced if necessary. The unit triggers an alarm when the combination of Removable Foam Filter and Fresh Gas/Emergency Air Intake Disk Filter become dirty. This alarm signifies that the unit is still able to deliver the correct tidal volume but one or more of its filters need replacement. The Fresh Gas/Emergency Air Intake Disk Filter can be visually inspected after the Removable Foam Filter is removed. If the filter appears discolored, it must be replaced.

Caution There are no user serviceable parts except the filter components above.

Caution When used in dusty/dirty environments, the foam and disk filters should be checked, and replaced as needed. This will prevent particle build up on the transducer screen and the need to take the unit out of service for maintenance by a biomedical technician.

Caution If filters have been exposed to biological matter, dispose of them following Universal Precaution procedures for your facility.

Note: Do not attempt to clean this filter and do not operate internal compressor without a filter in place.

Internal Filter Change/Insertion

Tools needed:

- Hemostat or tweezers
- Phillips Head screwdriver



Warning! Before attempting to replace filters, make sure that external power is disconnected and the unit's Power Switch is set to "OFF".

Procedures:

Foam Filter:

The Foam Filter is located inside the Compressor Inlet Fitting.



Carefully remove the Foam Filter using a hemostat or tweezers.

DO NOT reuse or attempt to clean the old filter.

Replace the Foam Filter with a new filter. Lightly tap the new filter into place. The top of the filter should reside approximately 3/4 to 7/8" below the height of the 22 mm female connector that is part of the Compressor Inlet Fitting.

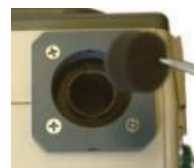

Disk Filter:



Remove the four (4) 8-32 x 3 Phillips Flat Head screws that secure the Compressor Inlet Fitting Assembly to the SPM Chassis.

Lift the two (2) segments of the Compressor Inlet Fitting Assembly away from the unit. If the two segments come apart, **do not** lose the gasket that seats between the parts.



The Disk Filter is now exposed. **Do not** remove the filter at this time.

Examine the surface of the Disk Filter. **Do not** replace the Disk Filter if it isn't discolored. If the Disk Filter is discolored, replacement is necessary.



Remove the Disk Filter using the hemostat or tweezers and replace it with a new, clean filter. Make sure that the filter sits flat on the shoulder in its recessed area.

Set the lower segment of the Compressor Inlet Fitting Assembly into the unit, making sure that its alignment pin mates.

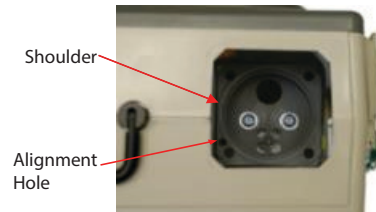

Set the upper segment of the Compressor Inlet Fitting Assembly into the lower segment, making sure that its alignment pin mates.

Secure the Compressor Inlet Fitting Assembly to the SPM Chassis by equally tightening each of the four (4) 8-32 x 3 Phillips Flat Head screws.

Momentarily turn the unit's **POWER** switch to its "ON" position to confirm operating power.

A *DISCONNECT* alarm will sound.

Turn the unit's **POWER** switch to its "OFF" position.

Post-Contaminated Environment Cleaning

If the ventilator is operated in an environment where it may have been exposed to contamination from a hazardous materials accident, mass epidemic, or weapon of mass destruction, ZOLL recommends that the guidelines below are followed:

1. Always follow the decontamination procedures specified by the local Incident Command Safety Officer.
2. Equipment should be cleaned and decontaminated as soon as possible after use. Personnel should always wear the appropriate Personal Protective Equipment while decontaminating equipment.
3. The ventilator's outer case should be cleaned with a damp, soapy cloth and thoroughly dried with a lint-free cloth. Make sure that all exposed surfaces are cleaned and dried.
4. For general decontamination/cleaning situations, a 10% bleach solution applied with a damp cloth is an effective decontaminant that can be used. Since the potential amount of contaminants that the ventilator might be exposed to is so large, it is difficult to provide an appropriate cleaning method for each type of exposure. An effective cleaning agent for one type of exposure may not be effective with another and cleaning and sterilizing practices may vary between institutions. ZOLL suggests that each facility have in place a procedure for the cleaning and disinfection of its medical equipment and that these procedures be consulted for further guidance.
5. Care must be taken to prevent liquids from entering the ventilator. Never submerge the ventilator and avoid using excessive amounts of water that might enter the unit.
6. Never use abrasives or chlorinated hydrocarbon based cleansers when cleaning the ventilator, they will damage the plastic and interface lens.

Battery Maintenance

Battery Capacity

While the unit is operating on battery power, operators can best determine the relative amount of charge in the internal battery by looking at the Battery Icon/Indicator. The Battery icon appears in outline form and is filled with horizontal rows of lines indicating its current capacity. Each line represents 5% of battery capacity.

Battery Care and Charging

The unit uses a rechargeable lithium-ion battery, which offers a wide temperature operating range, does not exhibit “memory” characteristics (reduced capacity), or vent hydrogen gas. The life of this battery depends, to a great extent, upon the care it receives. Avoid exposing it to direct sunlight or heat sources and never store the battery at temperatures above 76°C (170°F) for more than 2 hours. Following these simple guidelines will prevent premature charge depletion and reduction of battery life.

Caution	Only use the Power Supply provided with the unit (ZOLL PN 703-0731-01). Use of any other power supply could cause damage or create a fire and/or destroy the battery and unit.
----------------	--

Caution	If you witness a battery or the battery compartment starting to balloon, swell up, smoke, or feel excessively hot, turn off the unit, disconnect external power, and observe it in a safe place for approximately 15 minutes and send the unit for service. Never puncture or disassemble the battery packs or cells.
----------------	---

Caution	Never attempt to completely discharge the battery by shorting or some other method and never ship the battery in a completely discharged state.
----------------	---

Caution	During continuous, uninterrupted use (>100 hours), it is recommended that the ventilator be disconnected from AC power for 30 seconds to allow the battery to run diagnostics while the battery is discharging.
----------------	---

Note: The ventilator continuously monitors the available power sources; occasionally a false Low Priority power alarm can be triggered for ~1 second. These false alarms immediately clear themselves.

1. Battery charging is controlled by the ventilator in the temperature range of 0°C to 45°C (32°F to 113°F) to provide the best life time for the battery.
2. The battery has a discharge (operational) temperature range of -25°C to 49°C (5°F to 71°F) (as verified by ZOLL).
3. DO NOT store the ventilator with the batteries discharged. Always store with the battery fully charged.
4. For long-term storage, the optimum storage temperature range is -15°C to 21°C (5°F to 71°F).

Lithium-ion batteries exhibit excellent charge retention characteristics. Prolonged periods of disuse will not substantially reduce operating capability. If long-term storage/non-use is common, recharge the unit every six months; this will insure that battery charge is maintained at 80% capacity or better. The unit battery rapidly recharges to 90% of its capacity in approximately 2 hours. It will take approximately another 2 hours of trickle-charging to top off the battery to 100% of its capacity. Continuous charging is permissible with the supplied 12 VDC Power Cable or AC/DC Power Supply.

Operating power will always default to the external power source to preserve the internal battery charge. This assure that power is available for transport use or emergency back up. If the *EXTERNAL POWER LOW/FAIL* alarm occurs, the unit will automatically revert to its internal batteries for operating power.

The Battery Icon/Indicator indicates (1) the presence of a functional battery, (2) when the battery is charging, and (3) what its current capacity is. The Battery icon appears in outline form and is filled with horizontal rows of lines indicating its current capacity. When the battery is charging, these horizontal lines cyclically scroll vertically, one row at a time, from the bottom row to the top. When the battery is fully charged, the icon is completely filled with lines and scrolling stops. Each line represents approximately 5% of battery capacity. During internal battery operation, a horizontal line “disappears” as battery capacity is reduced by a 5% increment. The Battery icon will flash off/on when a *BATTERY POWER LOW* alarm occurs. The icon will flash off/on and present a diagonal line when no battery is connected.

Internal Battery Change/Insertion

Tools needed:

Phillips Head
Screwdriver



Warning! Before attempting to replace the battery pack (ZOLL PN 703-0731-01), make sure that external power is disconnected and the unit's Power Switch is set to "OFF".

Procedure:

Remove the four (4) 6-32 x 5/16 Phillips Pan Head screws located at the bottom of the unit. This will release the Battery Pack Compartment Cover and expose the Battery Pack and its integral mounting bracket.

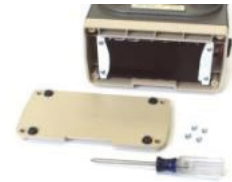

Remove the four (4) 6-32 x 2 1/4 Phillips Pan Head screws that hold the Battery Pack and its integral mounting bracket to the unit's Lower Case.

The unit's Battery Pack is wired to a mating plug-and-socket connector that remains electrically attached to the unit. This mating connector includes a locking latch.

While holding the Battery Pack in one hand, pinch the connector plug locking latch while pulling outward. This will release the plug from its mating socket and free the Battery Pack.



Replace the old Battery Pack with a new Battery Pack.

Align the plug, then insert the Battery Pack into its mating socket. The plug and socket are keyed to protect against misconnection.

Momentarily turn the unit's **POWER** switch to its "ON" position to confirm operating power. A *DISCONNECT* Alarm will sound.

Turn the unit's **POWER** switch to its "OFF" position.



Secure the Battery Pack with its integral mounting bracket to the unit's Lower Case using the four (4) 6-32 x 2 1/4 Phillips Pan Head screws.

Warning! Make sure that none of the Battery Pack wires get pinched between the bracket and case enclosure.

Align the Battery Pack Compartment Cover and secure it with the four (4) 6-32 x 5/16 Phillips Pan Head screws.

Momentarily turn the unit's **POWER** switch to its "ON" position to confirm operating power. A *DISCONNECT* Alarm will sound. Verify the charge status of the new Battery Pack. Turn the unit's **POWER** switch to its "OFF" position. If required, place the unit on charge.

Recharging Guidelines

1. Do not store the ventilator at 100% battery charge in a high temperature environment (~40°C/104°F and above) for long periods. Doing this may affect the usable life of the battery.
2. When charging in the storage case, be advised that the battery may stop charging if ambient temperature is above 40°C/104°F even though the unit is still connected to external power. Under these conditions, battery temperature can get as high as 10°C/50°F above the ambient temperature. Charging will automatically start when the ambient temperature drops.



ZOLL Ventilator Storage Case

Troubleshooting

Authorization to service this instrument by other than factory-trained and certified personnel will not be given, nor does ZOLL assume any responsibility and/or liability resulting from such unauthorized servicing.

Operator Correctable Problems

Common problems may be quickly rectified by the operator following the alarm mitigation instructions. Should this device fail to operate properly, verify the integrity of all hose, tubing, and fitting connections. Check all control panel settings and follow the alarm mitigation instructions provided in the Alarm Message Center (AMC). Verify that the Fresh Gas/Emergency Air Intake Disk Filter and Removable Foam Filter are not clogged or dirty. Check for operating power with internal batteries and external power source(s).

Operating Problems Requiring Service

If the tests above do not resolve an operating problem, service is required. Should servicing be necessary, contact the closest authorized ZOLL Service Center or the ZOLL Customer Service Department (1-973-882-1212). When calling or emailing for support, be sure to have the service code number associated with the fault or failure. A Returned-Goods-Authorization number (RGA #) will be issued if the problem cannot be resolved. The RGA # must appear on both the packing slip and address label. This will facilitate better tracking of returned items and result in improved scheduling and handling. Please have the model and serial number ready and any other pertinent data you wish to include in the service request. The unit's Serial Number Label is affixed to the back cover. This information is also contained in the User Menu, Unit Info.

Storage

For optimal prolonged storage periods, the unit should be stored indoors. The environment should be clean and out of direct sunlight. Storage in non-controlled environments is permissible if batteries are removed.

Short-term storage temperature should range between -15°C to 40°C (5°F to 104°F) and relative humidity should be low. For long-term storage, the optimum storage temperature range is -15°C to 21°C (5°F to 71°F). Battery life is diminished at temperatures above 35°C (95°F). It is recommended that batteries be discharged to 50% capacity if long-term storage above 35°C (95°F) is expected.

Caution DO NOT store batteries in a discharged condition.

When batteries are in extended storage, it is recommended that they receive a refresh charge at recommended intervals when *not* continuously connected to an external power source:

STORAGE AMBIENT	RECHARGE INTERVAL
Below 68°F (20°C)	12 months
68°F to 86°F (20°C to 30°C)	6 months
86°F to 104°F (30°C to 40°C)	3 months

Following periods of extended storage in non-controlled environments, allow the unit sufficient time to stabilize to a temperature within its specified operating range.

Following 6 months of continuous storage/non-use, or longer, the device should be examined, operationally tested, and its batteries recharged before patient use is attempted. Service may be required. Servicing should be performed by only qualified personnel.

Appendix A

Specifications

General

Parameter	Operating Range
Operating Modes	EMV+ [®] and Eagle II [™] : AC, SIMV, CPAP with and without Pressure Support, and with and without Noninvasive Positive Pressure Ventilation (NPPV/PPV) AEV [®] : AC, CPAP with and without Pressure Support, and with Noninvasive Positive Pressure Ventilation (NPPV)
Breath Target	Volume and pressure
Flow Rate	0 to 100 LPM at 40 cm H ₂ O (3922 Pa)
Breath Rate	1 to 60 BPM
Tidal Volume	50 to 1500 ml ATPD +/- 10% of setting
Inspiratory Time	0.3 to 3.0 seconds
FIO ₂	21 to 100% +/- 3% of full scale +/- 10% of setting
PEEP	0 to 25 cm H ₂ O (0 to 2451 Pa) (The minimum PEEP in CPAP-NPPV mode is 3 cm H ₂ O)
Peak Inspiratory Pressure (PIP)	10 to 80 cm H ₂ O (980 to 7845 Pa) (values >60 cm H ₂ O require secondary user confirmation) +/- 5 cm H ₂ O +/- 10% of setting
Oxygen Input Pressure	55 psig (-25%; +20%) (379170 Pa)
Airway Pressure High Limit	20 to 100 cm H ₂ O (1961 to 9806 Pa)
Airway Pressure Low Limit	Off, 3 to 35 cm H ₂ O (294 to 3432 Pa)
Breath Trigger	-6.0 to -0.5 cm H ₂ O (-588 to -49 Pa) below baseline/PEEP
PIP Bar Graph	-10 to 100 cm H ₂ O (-980 to 9806 Pa)

SPECIFICATIONS

Parameter	Operating Range
LED Status/Alarm Indicator	Red, Yellow, and Green
Alarm Volume	82 dBA @ 1 meter
Noise Level	~60 dBA when measured at 1 meter (operating at default settings using the compressor only)
Operating Voltages	100 to 240 VAC (50/60 and 400 Hz) or 12.5 to 28.0 VDC, verified by ZOLL 100 to 240 VAC (50/60 Hz) or 12.5 to 28.0 VDC, SGS listed
Operating Time Internal Battery	10 hours at default settings
Temperature Ranges Operating	-25°C to 49°C (-13°F to 120°F) with battery discharge and AC power operation based on ZOLL validation
Battery Charging	10°C to 40°C (50°F to 104°F) with battery charging, battery discharge, and AC power operation (SGS listed)
Long Term Storage	0°C to 45°C (32°F to 113°F)
	-15°C to 21°C (5°F to 71°F) Optimal storage conditions
Control Accuracy/Precision	± 10% of setting for all measured values and controls not other specified
Size	8.0" Wide X 12.5" High X 4.5" Deep (20.3 cm Wide X 31.8 cm High X 11.4 cm Deep)
Weight	~9.7 lbs (4.4 kg)
Warranty	Limited, 1 year

Pulse Oximeter

Range

Saturation (% SpO ₂)	1%-100%
Pulse Rate (bpm)	25-240
Perfusion	0.02%-20%

Accuracy

Saturation (% SpO₂)-During No Motion Conditions

Adults, Pediatrics 70%-100% ± 2 digits
0%-69% unspecified

Neonates 70%-100% ± 3 digits
0%-69% unspecified

Saturation (% SpO₂)-During Motion Conditions

Adults, Pediatrics 70%-100% ± 3 digits
0%-69% unspecified

Neonates 70%-100% ± 3 digits
0%-69% unspecified

Pulse Rate (bpm)-During No Motion Conditions

Adults, Pediatric, Neonates 25 to 240 ± 3 digits

Pulse Rate (bpm)-During Motion Conditions

Adults, Pediatric, Neonates 25 to 240 ± 5 digits

Resolution

Saturation (% SpO₂) 1%
Pulse Rate (bpm) 1

Low Perfusion Performance

>0.02% Pulse Amplitude Saturation (% SpO₂) ± 2 digits
and % Transmission >5% Pulse Rate ± 3 digits

Interfering Substances

Carboxyhemoglobin may erroneously increase readings. The level of increase is approximately equal to the amount of carboxyhemoglobin present. Dyes, or any substance containing dyes, that change usual arterial pigmentation may cause erroneous readings.

IEC 60601-1

This unit meets the Classification requirements of IEC 60601-1 (3.1 edition) as indicated by the following table:

IEC 60601-1 Clause	Category	Classification
6.2	Type of Protection against Electric Shock	Class I: Protection against electric shock does not rely on Basic Insulation only, but includes an additional safety precaution in that means are provided for the connection of the equipment to the protective earth conductor in the fixed wiring of the installation in such a way that accessible metal parts cannot become live in the event of a failure of the basic insulation. The medical power supply (which contains the system's safety barrier) is labeled as Class I or Class II. Electrical shock protection is not dependent upon earthing since this power supply design includes double insulation.
6.2	Degree of Protection against Electric Shock	BF: Type B with floating (F-type) parts
6.3	Degree of Protection against Harmful Ingress of Water	IPX4: Splash-proof equipment (protected against splashing water when enclosed in padded case/rain flap with bacterial/viral filter protecting compressor.)
6.4	Method of Sterilization or Disinfection	Pressure hose connections should be wiped with a damp, soapy cloth and thoroughly dried with a lint-free cloth. The unit's housing should also be cleaned as necessary with a damp, soapy cloth and thoroughly dried with a lint-free cloth. Do not clean with abrasives or chlorinated hydrocarbon cleansers.
6.5	Degree of Safety of Application in the presence of a Flammable Anesthetic Mixture with Air or with Oxygen or Nitrous Oxide	Equipment <i>not</i> suitable for use in presence of Flammable Anesthetic Mixture of Air or with Oxygen or Nitrous Oxide
6.6	Mode of Operation	Continuous Operation
7.9.2.5	Applied Parts	Ventilator circuit is Type BF applied part. Pulse Oximeter is Type BF Defibrillation Proof Applied Part.

The following tables provide the EMC test specifications as required by IEC 60601-1-2.

IEC 60601-1-2 clause 5.2.2.1 c

Guidance and manufacturer's declaration-electromagnetic emissions		
The ZOLL ventilators are intended for use in the electromagnetic environment specified below. The customer or user of the ventilator should ensure that they are used in such an environment		
Emissions test	Compliance	Electromagnetic environment-guidance
RF emissions CISPR 11	Group 1	The ZOLL ventilators use RF energy only for their internal function. Therefore, their RF emissions are very low and are not likely to cause any interference in nearby electronic equipment.
RF emissions CISPR 11	Class A	The ZOLL ventilators are suitable for use in all establishments other than domestic and those directly connected to the public low-voltage power supply network that supplies buildings used for domestic purposes.
Harmonic emissions IEF 61000-3-2	Class A	
Voltage fluctuations/flicker emissions IEC 61000-3-3	Complies	

IEC 60601-1-2 clause 5.2.2.1 f

Guidance and manufacturer's declaration-electromagnetic emissions			
The ZOLL ventilators are intended for use in the electromagnetic environment specified below. The customer or user of the ventilator should ensure that they are used in such an environment			
Immunity Test	IEC 60601 test level	Compliance level	Electromagnetic environment-guidance
Electrostatic discharge (ESD) IEC 61000-4-2	+/- 6 kV contact +/- 8 kV air	+/- 6 kV contact +/- 8 kV air	Floors should be wood, concrete, or ceramic tile. If floors are covered with synthetic material, the relative humidity should be at least 30%.
Electrical fast transient/burst IEC 61000-4-4	+/- 2 kV for power supply lines +/- 1 kV for input/output lines	+/- 2 kV for power supply lines +/- 1 kV for input/output lines	Mains power quality should be that of a typical commercial or hospital environment.
Surge IEC 61000-4-5	+/- 1 kV line(s) to line(s) +/- 2 kV line(s) to earth	+/- 1 kV line(s) to line(s) +/- 2 kV line(s) to earth	Mains power quality should be that of a typical commercial or hospital environment.
Voltage dips, short interruptions, and voltage variations on power supply input lines IEC 61000-4-11	< 5% U_T (> 95% dip in U_T) for 0.5 cycles 40% U_T (60% dip in U_T) for 5 cycles 70% U_T (30% dip in U_T) for 25 cycles < 5% U_T (> 95% dip in U_T) for 5 sec	< 5% U_T (> 95% dip in U_T) for 0.5 cycles 40% U_T (60% dip in U_T) for 5 cycles 70% U_T (30% dip in U_T) for 25 cycles < 5% U_T (> 95% dip in U_T) for 5 sec	Mains power quality should be that of a typical commercial or hospital environment. If the user of the ZOLL ventilators requires continued operation during power mains interruptions, it is recommended that the ventilator be powered from an uninterruptible power supply or a battery.
Power frequency (50/60) magnetic field IEC 6100-4-8	3 A/m	3 A/m	Power frequency magnetic fields should be at levels characteristic of a typical location at a typical commercial or hospital environment.
Note: U_T is the AC mains voltage prior to application of the test level			

IEC 60601-1-2 clause 5.2.2.2: life support equipment

Guidance and manufacturer's declaration-electromagnetic emissions			
The ZOLL ventilators are intended for use in the electromagnetic environment specified below. The customer or user of the ventilator should ensure that they are used in such an environment			
Immunity Test	IEC 60601 test level	Compliance level	Electromagnetic environment-guidance
			Portable and mobile RF communications equipment should be used no closer to any part of the ZOLL ventilator, including cables, than the recommended separation distance calculated from the equation applicable to the frequency of the transmitter. Recommended separation distance
Conducted RF IEC 61000-4-6	3 Vrms 150 kHz to 80 MHz outside ISM bands ^a	3 V	$d = 1.17 \sqrt{P}$
	10 Vrms 150 kHz to 80MHz outside ISM bands ^a	10 V	$d = 1.12 \sqrt{P}$
Radiated RF IEC 61000-4-3	10 V/m 80 MHz to 2.5 GHz	20 V/m	$d = 0.6 \sqrt{P}$ 80 MHz to 800 MHz $d = 1.15 \sqrt{P}$ 800 MHz to 2.5 MHz Where P is the maximum output power rating of the transmitter in watts (W) according to the transmitter manufacturer and d is the recommended separation distance in meters (m). ^b Field strengths from fixed RF transmitters, as determined by an electromagnetic site survey ^c , should be less than the compliance level in each frequency range. ^d Interference may occurring the vicinity of equipment marked with the following symbol:
<p>Note 1: At 80 MHz and 800 MHz, the higher frequency range applies.</p> <p>Note 2: These guidelines may not apply in all situations. Electromagnetic propagation is affected by absorption and reflection from structures, objects, and people.</p>			



- a. The ISM (industrial, scientific, and medical) bands between 150 kHz and 80 MHz are 6.765 MHz to 6.795 MHz; 13.553 MHz to 13.567 MHz; 26.957 MHz to 27.283 MHz; and 40.66 MHz to 40.70 MHz.
- b. The compliance levels in the ISM frequency bands between 150 kHz and 80 MHz and in the frequency range 80 MHz to 2.5 GHz are intended to decrease the likelihood that mobile/portable communications equipment could cause interference if it is inadvertently brought into patient areas. For this reason, an additional factor of 10/3 has been incorporated into the formula used in calculating the recommended separation distance for transmitters in these frequency ranges.
- c. Field strengths from fixed transmitters, such as base stations for radio (cellular/cordless) telephones and land mobile radios, amateur radio, AM and FM radio broadcast, and TV broadcast cannot be predicted theoretically with accuracy. To assess the electromagnetic environment due to fixed RF transmitters, an electromagnetic site survey should be considered. If the measured field strength in the location in which the ventilator is used exceeds the applicable RF compliance level above, the ventilator should be observed to verify normal operation. If abnormal performance is observed, additional measures may be necessary, such as reorienting or relocating the ventilator.
- d. Over the frequency range 150 kHz to 80 MHz, field strength should be less than 3 V/m.

IEC 60601-1-2 clause 5.2.2.2: life support equipment

Recommended separation distances between portable and mobile RF communications equipment and the ZOLL ventilators.

The ZOLL ventilators are intended for use in an electromagnetic environment in which radiated RF disturbances are controlled. The customer or the user of the ZOLL ventilators can help prevent electromagnetic interference by maintaining a minimum distance between portable and mobile RF communication equipment (transmitters) and the ZOLL ventilators as recommended below, according to the maximum output power of the communication equipment.

Rated maximum output power of transmitter (W)	Separation distance according to frequency of transmitter (m)			
	150 kHz to 80 MHz outside ISM bands $d = 1.17 \sqrt{P}$	150 kHz to 80 MHz in ISM bands $d = 1.12 \sqrt{P}$	80 MHz to 800 MHz $d = 0.6 \sqrt{P}$	800 MHz to 2.5 GHz $d = 1.15 \sqrt{P}$
0.01	0.117	0.12	0.06	0.115
0.1	0.37	0.38	0.19	0.36
1	1.17	1.2	0.6	1.15
10	3.7	3.8	1.9	3.6
100	11.7	12	6	11.5

For transmitters rated at a maximum output power not listed above, the recommended separation distance d in meters (m) can be determined using the equation applicable to the frequency of the transmitter, where P is the maximum output power rating of the transmitter in watts (W) according to the transmitter manufacturer.

Note 1: At 80 MHz and 800 MHz, the separation distance for the higher frequency applies.

Note 2: The ISM (industrial, scientific, and medical) bands between 150 kHz and 80 MHz are 6.765 MHz to 6.795 MHz; 13.553 MHz to 13.567 MHz; 26.957 MHz to 27.283 MHz; and 40.66 MHz to 40.70 MHz.

Note 3: An additional factor of 10/3 has been incorporated into the formula used in calculating the recommended separation distance for transmitters in the ISM frequency bands between 150 kHz and 80 MHz and in the frequency range of 80 MHz to 2.5 GHz to decrease the likelihood that mobile/portable communications equipment could cause interference if it is inadvertently brought into patient areas.

Note 4: These guidelines may not apply in all situations. Electromagnetic propagation is affected by absorption and reflection from structures, objects, and people.

The unit was tested for the effect of pressure at the patient connection port (e.g airway pressure) on the V_T and Oxygen concentration.

The tests consisted of a core matrix of volume or pressure targets for a set of resistances and compliances, based on the ASTM F1100 guidance. These test cases were then performed at different PEEP targets, FIO_2 settings, and with different patient circuit accessories and Fresh Gas Intake accessories. The possible settings and accessories are listed below:

Setting/Accessories	Value
PEEP Settings	0, 5, 25
FIO_2 Settings	21, 30, 50, 90, 100
Patient Circuit Accessories	No Accessory HME HME + BV HMEBV
Intake Filter Accessories	No Accessory C2A1 BV Filter O2 Reservoir

The following accuracies/precision were observed for adult settings with non-MRI breathing circuit:

Parameter	Accuracy/Precision
V_T , Tidal Volume	$\pm 10\%$ of setting
Pressure Target Accuracy	± 5 cm H_2O for setting < 30, else ± 10 cm H_2O
PEEP Accuracy	± 1.5 cm $H_2O \pm 10$ of setting
FIO_2 Accuracy	$\pm 3\%$ of full scale ± 10 of setting

Appendix B

Accessories

The following accessories are comparable for use with the ZOLL ventilator. To order any of these items, contact ZOLL or your local distributor.

Part Number	Part Description
024-0012-00	AC/DC Power Supply, 100-240 VAC, 100 W, 24 V, 4.2 A, IEC 320 Plug
708-0042-00	AC Power line cord, 6' (United States Version)
703-0731-01	Battery Pack, 6.6 Ah, 14.8 V, Lithium-Ion, 4S3P
710-0731-01	AC/DC Power Supply and Line Cord with NEMA 5-15P termination
704-0EMV-XX	Extension Cord 8' US Hospital Grade Female Plug to Country-Specific Connector (Contact factory for complete part number for each country)
708-0041-XX	Cordset, 6', IEC 60320-C5 Plug to Country-Specific Connector (Contact factory for complete part number for each country)
402-0032-00	Padded Carry Case, Tan, for Ventilator and Accessories
465-0024-00	Filter, Bacterial/Viral (B/V)
465-0025-00	Filter, HME/B/V, Heat and Moisture Exchanger
465-0027-00	Filter, Disk, B/V, Emergency Air Intake
465-0028-00	Removable foam compressor inlet filter
820-0108-00	Heat and Moisture Exchanger/Bacterial and Viral Filter (HMEF), Adult, Deadspace \leq 75ml
820-0108-25	Heat and Moisture Exchanger/Bacterial and Viral Filter (HMEF), Adult, Deadspace \leq 75ml (Case of 25)
820-0109-00	Heat and Moisture Exchanger/Bacterial and Viral Filter (HMEF), Pediatric, Deadspace \leq 25ml

ACCESSORIES

Part Number	Part Description
820-0109-25	Heat and Moisture Exchanger/Bacterial and Viral Filter (HMEF), Pediatric, Deadspace ≤ 25ml (Case of 25)
820-0110-00	Heat and Moisture Exchanger/Bacterial and Viral Filter (HMEF), Infant, Deadspace ≤ 10ml
820-0110-25	Heat and Moisture Exchanger/Bacterial and Viral Filter (HMEF), Infant, Deadspace ≤ 10ml (Case of 25)
820-0111-00	Adaptor, Metered Dose Inhaler, Adult
820-0111-25	Adaptor, Metered Dose Inhaler, Adult (Case of 25)
820-0112-00	Adaptor, Metered Dose Inhaler, Pediatric/Infant
820-0112-25	Adaptor, Metered Dose Inhaler, Pediatric/Infant (Case of 25)
704-0004-00	3 Liter O ₂ Reservoir Kit
704-0EMV-05	DC Power Cable, 28 VDC, Military Vehicle
704-0EMV-06	DC Power Cable, 12 VDC, Ambulance
708-0036-00	Cable, 3ft, Masimo SET Oximeter, LNCS Type DC-1, Adult Digit Sensor to DB9 Male Note: All LNCS Masimo cables are approved for use with the ZOLL ventilators
708-0037-00	Cable, 4ft, Masimo LNCS Patient Cable Type LNC-4, DB9 Female to Male Note: All LNCS Masimo cables are approved for use with the ZOLL ventilators
708-0039-00	Cable, 3ft, Masimo Adult Ear Sensor, LNCS Type DC-1, Adult Sensor to DB9 Male Note: All LNCS Masimo cables are approved for use with the ZOLL ventilators
708-0046-00	Cable, 6ft, BS 546 (UK-SA) Plug Right Angle
708-0047-00	Cable, 3ft, Masimo SET Oximeter, LNCS Type Inf/Inf-3, Infant Sensor to DB9 Male
708-0052-00	Cable, 3ft, Pulse Oximeter, Reusable, Finger Sensor, Pediatric
708-0053-00	Cable, 18", Pulse Oximeter, Disposable, Finger Sensor, Adult
708-0054-00	Cable, 18", Pulse Oximeter, Disposable, Finger Sensor, Pediatric
708-0056-00	Cable, 3ft, Masimo SET Oximeter, LNCS Type DC-1, Adult Digit Sensor to DB9 Male, Single Patient Note: All LNCS Masimo cables are approved for use with the ZOLL ventilators
708-0057-00	Cable, 3ft, Masimo SET Oximeter, LNCS Type DC-1, Pediatric Digit Sensor to DB9 Male, Single Patient Note: All LNCS Masimo cables are approved for use with the ZOLL ventilators
708-0063-00	Extension Cord Assembly, AS 3112 (Australian) Plug to US Hospital Grade Plug
708-0064-00	Cable, 6ft, Continental Europe CEE 7/7 to IEC-60320-C5 2.5 Amp Connector
820-0106-00	Circuit, Vent, Single Limb, Pediatric/Adult (disposable)
820-0106-15	Circuit, Vent, Single Limb, Pediatric/Adult (disposable) (Case of 15)
820-0107-00	Circuit, Vent, Single Limb, Infant/Pediatric (disposable)
820-0107-20	Circuit, Vent, Single Limb, Infant/Pediatric (disposable) (Case of 20)

Part Number	Part Description
820-0130-00	MRI Circuit, Vent, Single Limb, Pediatric/Adult (disposable)
820-0130-10	MRI Circuit, Vent, Single Limb, Pediatric/Adult (disposable) (Case of 10)
820-0131-00	MRI Circuit, Vent, Single Limb, Infant/Pediatric (disposable)
820-0131-10	MRI Circuit, Vent, Single Limb, Infant/Pediatric (disposable) (Case of 10)
820-0133-00	Circuit, Vent, Single Limb, Wye, Adult/Pediatric (disposable) with Accessory Port Connector
820-0133-15	Circuit, Vent, Single Limb, Wye, Adult/Pediatric (disposable) with Accessory Port Connector (Case of 15)
820-0134-00	MRI Circuit, Vent, Single Limb, Wye, Adult/Pediatric (disposable) with Accessory Connector
820-0134-10	MRI Circuit, Vent, Single Limb, Wye, Adult/Pediatric (disposable) with Accessory Connector (Case of 10)
825-0002-00	High pressure Oxygen Hose, DISS x DISS, oxygen, 6'
907-0731-03	Quick Reference Guide, laminated, Model 731 (non-MRI)
907-0731-04	Quick Reference Guide, laminated, Model 731 (MRI)
907-0731-05	Tag, Laminated, MRI Cautions/Warnings
906-0731-01	Operator's Guide (Commercial), Model 731
909-0731-01	CD format Operator's Guide (Commercial), Model 731
906-0731-03	Operator's Guide (Military), Model 731
909-0731-02	CD format Operator's Guide (Military), Model 731
906-0731-06	Operator's Guide (Commercial, Spanish), Model 731
909-0731-06	CD format Operator's Guide (Commercial, Spanish), Model 731
906-0731-07	Operator's Guide (Commercial, Portuguese), Model 731
909-0731-07	CD format Operator's Guide (Commercial, Portuguese), Model 731
906-0731-08	Operator's Guide (Commercial, Polish), Model 731
909-0731-09	CD format Operator's Guide (Commercial, Polish), Model 731
906-0731-04	Service Manual
909-0731-04	CD format Service Manual
816-0731-00	Non-MRI Rolling Cart
816-0731-01	MRI conditional Rolling Cart
704-0731-09	IV support arm for Rolling Cart (aluminum, MRI safe)
820-0124-00	Breathing Circuit support arm for Rolling Cart (ferrous, not for MRI use)
800-0904-01	CCLAW (Critical Care Litter Attachment Widget) Mounting Bracket
703-0731-03	Carry-all Case with Foam Inserts, without AC Receptacle
703-0EMV-03	Carry-all Case with AC Receptacle

ACCESSORIES

Part Number	Part Description
703-0731-11	Case, Transit Carry
703-0731-12	Case, Transit Carry, with AC Bulkhead Connector
703-0731-13	Case, Transit Carry, with AC Bulkhead & USB Connectors
703-0731-14	Case, Transit Carry, with Wheels & Pull-Out Handle
703-0731-15	Case, Transit Carry, with Wheels & Pull-Out Handle, AC Bulkhead Connector
704-0700-01	Check Valve Kit
812-0011-00	Mask, CPAP, #6, Large Adult
812-0011-20	Mask, CPAP, #6, Large Adult (Case of 20)
812-0010-00	Mask, CPAP, #5, Adult
812-0010-20	Mask, CPAP, #5, Adult (Case of 20)
812-0009-00	Mask, CPAP, #4, Child
812-0009-20	Mask, CPAP, #4, Child (Case of 20)
812-0008-00	Mask, CPAP, #3, Small Child
812-0008-20	Mask, CPAP, #3, Small Child (Case of 20)
812-0008-40	Mask, CPAP, #3, Small Child (Case of 40)
812-0007-00	Mask, CPAP, #2, Infant
812-0007-20	Mask, CPAP, #2, Infant (Case of 20)
812-0007-40	Mask, CPAP, #2, Infant (Case of 40)
812-0006-00	Mask, CPAP, #1, Small Infant
712-0004-00	Mask, CPAP, #4, Child with harness
712-0004-20	Mask, CPAP, #4, Child with Harness (Case of 20)
712-0004-50	Mask, CPAP, #4, Child with Harness (Case of 50)
712-0002-00	Mask, CPAP, #5, Adult with Harness
712-0002-20	Mask, CPAP, #5, Adult with Harness (Case of 20)
712-0002-50	Mask, CPAP, #5, Adult with Harness (Case of 50)
712-0003-00	Mask, CPAP, #6, Large Adult with Harness
712-0003-20	Mask, CPAP, #6, Large Adult with Harness (Case of 20)
712-0003-50	Mask, CPAP, #6, Large Adult with Harness (Case of 50)
334-0125-00	Harness, Mask, Universal
334-0125-00	Harness, Mask, Universal (Case of 10)
820-0132-00	600 ml ZOLL Test Lung, plastic/silicone

Index

A

Abbreviations	1-6
Accessories	B-1–B-4
Adjuncts of Operation	3-4–3-6
Alarm	
Cancellation in Alarm Configuration Menu	4-28
Categories	4-4–4-8
List	4-8–4-25
Priorities	4-3
Turn Off and Cancellation	4-26–4-27
Turn Off at Extreme Range Limits	4-27
Assembly	1-2

B

Back Up Ventilator	3-9
Battery	
Capacity	5-7
Care and Charging	5-7–5-8
Change/Insertion	5-9
Recharging	5-10
Begin Ventilating	3-7–3-8

C

Cautions	1-11
Change Settings	3-8–3-9
Connector Panel	
Exhalation Valve	2-7
External Power Input	2-7
Fresh Gas/Emergency Air Intake	2-7
Gas Output	2-7
Oxygen Input	2-7
Pulse Oximeter Connector	2-7
Transducer (Patient Airway Pressure)	2-7
USB Connector	2-7
Controls	2-8–2-16
BPM (Breathing Rate)	2-11–2-12
Confirm/Select	2-13
FIO2	2-10
HR	2-9–2-10
Manual Breath	2-13
Menu	2-13–2-16
Mode	2-12–2-13
Mute/Cancel	2-13
PIP	2-11
Power Off/On	2-13

Rotary Encoder	2-13
SpO2	2-10
Tidal Volume	2-11
Conventions	1-5
D	
Display Screen	2-17–2-19
Airway Pressure/Measured Values	2-19
Alarm Triangle Icon	2-19
Battery Icon	2-19
BPM (Breathing Rate)	2-18
Current Mode	2-18
External Power Icon	2-18
FIO2	2-18
Head with Mask Icon	2-19
HR	2-17
Mode	2-18
Oxygen Supply Icon	2-19
PIP	2-18
Pressure/Time Plot	2-18
Pulse Pleth/Time Plot	2-18
Speaker (Mute/Unmute) Icon	2-19
SpO2	2-17
Status Indicator LED Array	2-18
Tidal Volume	2-18
F	
FDA Tracking	1-12
Features	2-4
G	
Gas Sources	2-24–2-25
Guide Updates	1-1
H	
Harsh Environment Operation	
Airborne Particulates	3-13
Altitude	3-14
Extreme Temperature Environments	3-13
Rain and Snow	3-14
Hazardous Environment Filters	3-11–3-12
Bacterial/Viral	3-11
Change/Insertion	5-4–5-5
Check Valve on Breathing Circuit	3-12
Chemical/Biological	3-12
Foam Filter	5-2
Fresh Gas/Emergency Air Intake Disk Filter	5-3
How to Use	1-1
Humidification	3-9–3-10

<u>I</u>	
Indications	1-7
Features	1-7
<u>L</u>	
Limited Warranty	1-14
<u>M</u>	
Maintenance	
Calibration Checks	5-1
General Cleaning	5-2
Operating Problems Requiring Service	5-11
Operator Correctable Problems	5-11
Post-Contaminated Environment Cleaning	5-6
Preventative Maintenance	5-2
MRI	
Hazard Assessment	3-20
Test Details	3-18–3-19
Ventilator and Stand Configuration	3-19
Warnings and Cautions	3-21–3-22
<u>N</u>	
Notification of Adverse Events	1-13
<u>O</u>	
Operation	
Additional Adjuncts	3-4–3-6
Modes of	3-3
<u>P</u>	
Pneumatic Diagram	2-6
Pop Up Messages	2-20–2-22
List	2-21–2-22
Power	
Connections	2-30
Selection	2-29
Pulse Oximeter	
Description	3-9
Principles	2-32–2-33
Specifications	A-3
<u>S</u>	
Self-Check	2-31
Service	1-15–1-16
Set-up	2-23
Smart Help Messages	4-2–4-3
Software License	1-13
Specifications	
Accuracy/Precision	A-8
General	A-1–A-2
IEC 60601-1 Classifications	A-4–A-7
Pulse Oximeter	A-3

Spontaneous/Assisted Breath Trigger	3-6-3-7
Storage	5-11-5-12
Symbols	1-2-1-5
<u>T</u>	
Transducer Calibration (AUTO CAL)	2-31
<u>U</u>	
Unpacking	1-2
Use of Low Flow Oxygen	3-15-3-17
Operating Notes	3-16-3-17
Procedure	3-15
<u>V</u>	
Ventilator Circuit	
Connections	2-26
Patient Connections	2-27
Resistance, Compliance, and Deadspace	2-28-2-29
Ventilator Models	
AEV	2-2
Common Features	2-1
Eagle II	2-3
EMV+	2-2
MRI Variants	2-3
<u>W</u>	
Warnings	1-8-1-11
General	1-8-1-9
Pulse Oximeter	1-10-1-11